



IP Office 4.1

Key and Lamp Operation

Notice

While reasonable efforts were made to ensure that the information in this document was complete and accurate at the time of printing, Avaya Inc. can assume no liability for any errors. Changes and corrections to the information in this document may be incorporated in future releases.

Documentation Disclaimer

Avaya Inc. is not responsible for any modifications, additions, or deletions to the original published version of this documentation unless such modifications, additions, or deletions were performed by Avaya.

Link Disclaimer

Avaya Inc. is not responsible for the contents or reliability of any linked Web sites referenced elsewhere within this Documentation, and Avaya does not necessarily endorse the products, services, or information described or offered within them. We cannot guarantee that these links will work all of the time and we have no control over the availability of the linked pages.

License

USE OR INSTALLATION OF THE PRODUCT INDICATES THE END USER'S ACCEPTANCE OF THE TERMS SET FORTH HEREIN AND THE GENERAL LICENSE TERMS AVAILABLE ON THE AVAYA WEBSITE AT <http://support.avaya.com/LicenseInfo/> ("GENERAL LICENSE TERMS"). IF YOU DO NOT WISH TO BE BOUND BY THESE TERMS, YOU MUST RETURN THE PRODUCT(S) TO THE POINT OF PURCHASE WITHIN TEN (10) DAYS OF DELIVERY FOR A REFUND OR CREDIT.

Avaya grants End User a license within the scope of the license types described below. The applicable number of licenses and units of capacity for which the license is granted will be one (1), unless a different number of licenses or units of capacity is specified in the Documentation or other materials available to End User. "Designated Processor" means a single stand-alone computing device. "Server" means a Designated Processor that hosts a software application to be accessed by multiple users. "Software" means the computer programs in object code, originally licensed by Avaya and ultimately utilized by End User, whether as stand-alone Products or pre-installed on Hardware. "Hardware" means the standard hardware Products, originally sold by Avaya and ultimately utilized by End User.

License Type(s): Designated System(s) License (DS).

End User may install and use each copy of the Software on only one Designated Processor, unless a different number of Designated Processors is indicated in the Documentation or other materials available to End User. Avaya may require the Designated Processor(s) to be identified by type, serial number, feature key, location or other specific designation, or to be provided by End User to Avaya through electronic means established by Avaya specifically for this purpose.

Copyright

Except where expressly stated otherwise, the Product is protected by copyright and other laws respecting proprietary rights. Unauthorized reproduction, transfer, and or use can be a criminal, as well as a civil, offense under the applicable law.

Third-Party Components

Certain software programs or portions thereof included in the Product may contain software distributed under third party agreements ("Third Party Components"), which may contain terms that expand or limit rights to use certain portions of the Product ("Third Party Terms"). Information identifying Third Party Components and the Third Party Terms that apply to them is available on Avaya's web site at: <http://support.avaya.com/ThirdPartyLicense/>

Avaya Fraud Intervention

If you suspect that you are being victimized by toll fraud and you need technical assistance or support, call Technical Service Center Toll Fraud Intervention Hotline at +1-800-643-2353 for the United States and Canada. Suspected security vulnerabilities with Avaya Products should be reported to Avaya by sending mail to: securityalerts@avaya.com.

For additional support telephone numbers, see the Avaya Support web site (<http://www.avaya.com/support>).

Trademarks

Avaya and the Avaya logo are registered trademarks of Avaya Inc. in the United States of America and other jurisdictions. Unless otherwise provided in this document, marks identified by "®," "™" and "SM" are registered marks, trademarks and service marks, respectively, of Avaya Inc. All other trademarks are the property of their respective owners.

Documentation information

For the most current versions of documentation, go to the Avaya Support web site (<http://www.avaya.com/support>) or the IP Office Knowledge Base (<http://marketingtools.avaya.com/knowledgebase/>).

Avaya Support

Avaya provides indirect and direct services for customer support, report problems or to ask questions about your product. These services are subject to your support agreement. Contact your local reseller / distributor for indirect support . Contact Avaya Global Services (AGS) for direct support. For additional information on support, see the Avaya Web site: <http://www.avaya.com/support>.

Contents

Introduction	5	Other Appearance Controls	31
IP Office Key and Lamp Operation	5	Summary	31
Appearance Button Features	6	Selected Button Indication	32
IP Office Phones	8	Idle Line Preference	33
Call Appearance Buttons	9	Idle Line Preference Example 1	33
Call Appearance Buttons	9	Idle Line Preference Example 2	34
Call Appearance Example 1	10	Idle Line Preference Example 3	34
Call Appearance Example 2	11	Idle Line Preference Example 4	34
How are Call Appearance Buttons Treated?	12	Ringing Line Preference	35
Call Appearance Button Indication	13	Ringing Line Preference Example 1	36
Call Coverage Buttons	15	Ringing Line Preference Example 2	37
Call Coverage Appearance Buttons	15	Answer Pre-Select	38
Call Coverage Example 1	16	Answer Pre-Select Example 1	38
Call Coverage Example 2	16	Auto Hold	39
How is Call Coverage Treated?	17	Auto Hold Example 1	39
Call Coverage Button Indication	18	Ring Delay	40
Bridged Appearance Buttons	19	Ring Delay Example 1	41
Bridged Appearance Buttons	19	Delayed Ring Preference	42
Bridged Appearance Example 1	20	Delayed Ring Preference Example 1	42
Bridged Appearance Example 2	21	Delayed Ring Preference Example 2	43
Bridged Appearance Example 3	22	Collapsing Appearances	44
How are Bridged Appearances Treated?	23	Collapsing Appearances Example 1	44
Bridged Appearance Button Indication	24	Joining Calls (Bridging)	45
Line Appearance Buttons	25	Joining Example 1: Joining with a Line	
Line Appearance Buttons	25	Appearance	47
Line Appearance Example 1	26	Joining Example 2: Joining with a Bridged	
Line Appearance Example 2	27	Appearance	47
How are Line Appearances Treated?	28	Multiple Alerting Appearance Buttons	48
Line Appearance Button Indication	29	Twinning	49
		Busy on Held	49
		Reserving a Call Appearance Button	49
		Appearance Functions and Logging Off and	
		Hot Desking	50
		Remote Hot Desking	50
		Appearance Functions and IP Office	
		Applications	50
		Programming Appearance Buttons	51
		Appearance Function System Settings	51
		Appearance Function User Settings	52
		Programming Line Appearance ID Numbers	54
		Programming Appearance Buttons	55
		Outgoing Line Programming	57
		Upgrading from Pre-3.0 Systems	59
		Upgrading from Pre 3.0 IP Office	59
		Call Handling Changes	60
		Twin LED Button Users	62
		Twin LED Button Users Lamp States	63
		Glossary	65
		Index	67

Introduction

IP Office Key and Lamp Operation

Many Avaya phones supported on IP Office have a programmable keys or buttons (the terms 'key' and 'button' mean the same thing in this context). Various actions can be assigned to each of these keys, allowing the phone user to access that action.

Many of the phones also have indicator lamps next to the programmable buttons. These lamps are used to indicate the status of the button, for example 'on' or 'off'. On other phones the programmable buttons use an adjacent area of the phones display to show status icons and text labels for the buttons.

- **Example**

The example below shows the display and programmable buttons on an Avaya 5421 phone where a number of programmable features have been assigned to the user.

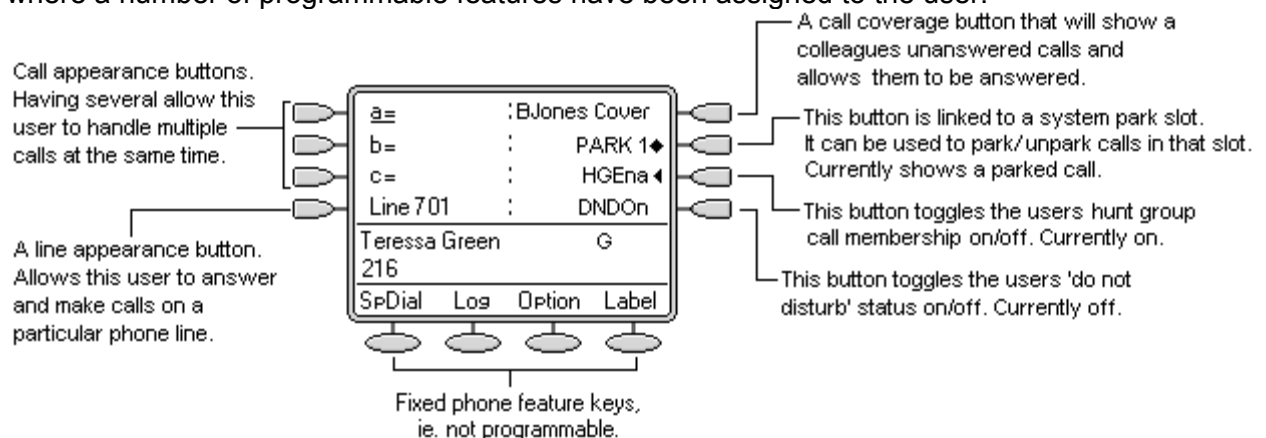

- This type of phone displays text labels for the programmed features. On other phones a paper label may have to be updated to indicate the programmed feature.

IP Office 3.0* and higher supports four 'appearance' actions - Call Appearance, Bridged Appearance, Line Appearance and Call Coverage Appearance. These actions can be assigned to the programmable buttons on a user's phone. Those 'appearance' buttons can then be used to answer, share, switch between and in some case make calls. This type of call handling is often called 'key and lamp mode'.

This document covers the programming and operation of phones using the appearance functions. Details of the other actions that can be assigned to programmable keys are covered in the "IP Office Button Programming Manual".

Note

- *IP Office 3.0DT does not support appearance buttons.
- For all the examples within this documentation, the **Auto Hold** function is on and **Answer Pre-Select** (4.0+) is off unless otherwise stated.
- The text shown on phone displays are typical and may vary between phone types, locales and IP Office software releases.

Appearance Button Features

Appearance functions are only supported on Avaya phones which have programmable buttons and also support multiple calls, see Key and Lamp Phones. Appearance functions are also only supported on those buttons that have suitable adjacent indicator lamps or a display area. Appearance buttons are not supported across Small Community Networks (SCN).

IP Office 3.0

The following key and lamp operation features were added in IP Office 3.0:

- **Call Appearance Buttons**
These are used to alert the phone user of calls to their extension number or a hunt group of which they are a member. Multiple call appearance buttons allow the user to handle multiple calls simultaneously.
- **Call Coverage Buttons**
A call coverage button can alert the user when a selected colleague has an unanswered call. The covered user does not need to be using appearance buttons.
- **Bridged Appearance Buttons**
A bridged appearance button shows the user the status of one of a colleague's call appearance buttons. They can then answer and make calls on the colleague's behalf.
- **Line Appearance Buttons**
These buttons show the user when a particular IP Office line is in use. The button can also be used to answer and make calls on that line. Supported for analog, E1 PRI, T1, T1 PRI, and BRI PSTN trunks. Not supported for E1R2, QSIG and IP trunks.
- **How Many Appearance Buttons can a user have?**
The recommended limits are as follows:
 - A minimum of 3 call appearance buttons except on phones that only support two physical programmable buttons.
 - A maximum of 10 bridged appearances to the same call appearance.
 - A maximum of 10 line appearances to the same line.
 - A maximum of 10 call coverages of the same covered user.
- **Selected Button Indication**
At any time, one appearance button can be indicated as the current selected button. It will then be the button used to make or answer a call if the user just goes off hook without pressing a particular button. There are a number of ways in which the current select button is determined.
 - **Idle Line Preference**
Sets the current selected button to the first available call appearance or line appearance button.
 - **Ringling Line Preference**
Sets the current selected button to the longest alerting appearance button.
 - If the user is already on a call then the selected button indication is given to the appearance button currently in use.
- **Auto Hold**
When a user active on a call on one appearance button presses another appearance button, the system can either hold or disconnect the current call. Which action is used is set by the IP Office system's **Auto Hold** setting which for IP Office 4.0+ is on by default.
- **Collapsing Appearances**
When several calls, on separate appearance buttons, are combined into a single conference, the active appearance buttons will collapse onto a single appearance button.

- **Joining a Call**
Appearance buttons can indicate calls in progress between other users. That button can then, subject to some intrusion rules, also be used to join that call.
- **Multiple Alerts**
It is possible for a single call to potentially alert of several appearance buttons. In such cases the IP Office employs a series of rules as to which appearance button will be used.

IP Office 3.2

The following key and lamp operation feature was added in IP Office 3.2:

- **Ring Delay**
IP Office 3.2 adds the option of ring delay for each appearance buttons. Each individual appearance button can be set to immediate ring, delayed ring or no ring. This setting does not alter the visual alerts given when the button receives a call. The delay used for all buttons is set by the system or overridden by the user's own delay setting.

IP Office 4.0

The following key and lamp operation features were added in IP Office 4.0:

- **Delayed Ring Preference**
This user telephony setting works in conjunction with the user's **Ring Line Preference** setting. It sets whether ringing line preference should use or ignore the ring delay applied to the user's appearance buttons.
- **Answer Pre-Select**
Normally when a user has multiple alerting calls, only the details of the call on current selected button are shown. Pressing any of the alerting buttons will answer the call on that button, going off-hook will answer the current selected button. Enabling the user telephony setting **Answer Pre-Select** allows the user to press any alerting button to make it the current selected button and displaying its call details without answering that call. To answer a call when the user has **Answer Pre-Select** enabled, the user must press the alerting button to display the call details and then either press the button again or go off-hook.
- **Reserve Last CA**
Phones with appearance buttons require a free call appearance button to perform actions such as call transfers. However it is possible in some scenarios for all available call appearances to be occupied or alerting. The user telephony setting **Reserve Last CA** can be used to restrict the user's last call appearance button for outgoing calls only.

IP Office 4.1

The following key and lamp operation features were added in IP Office 4.1:

- **Abbreviated Ring**
By default, once a user has a connected call, any additional calls alert with just a single ring, referred to as an abbreviated ring. For IP Office 4.1+ this can be changed to full ringing for additional calls. This is done through the **User | Telephony | Abbreviated Ring** option within the IP Office configuration.
- **Twinned Line/Bridge/Coverage Appearances**
Users with internal twinning have calls alerting at both a primary and secondary phone. Previously that only applied to calls alerting on call appearance buttons. The **User | Twinning** options **Twin Bridge Appearances**, **Twin Coverage Appearances** and **Twin Line Appearances** cause any calls alerting on those buttons on the users primary phone to also alert on the secondary phone. Note that twinning at the secondary ignores any ring delay settings.

IP Office Phones

The table below lists the phones supported by IP Office. Note that the range of phones supported varies with the IP Office control unit software level.

For some phones the annotation 24 (4x6) or similar is used. This can be read as 24 programmable buttons, arranged in as 4 screen pages with 6 physical buttons.

Phone	Buttons	Appearance	Button Type	IP Office Software Level							
				2.1	3.0DT	3.0	3.1	3.2	4.0	4.1	
2010	✗	—	✗	—	✓	✓	✗	✗	✗	✗	✗
2030	✓	8	✗		✓	✓	✗	✗	✗	✗	✗
2050	✓	8	✗		✓	✓	✗	✗	✗	✗	✗
20CC	✓	8	✗		✓	✓	✗	✗	✗	✗	✗
20DT	✗	0	✗	—	✓	✓	✓	✓	✓	✓	✓
2402D	✓	2 (+12)	✓		✗	✗	✓	✓	✓	✓	✓
2410D	✓	12 (2x6)	✓		✗	✗	✓	✓	✓	✓	✓
2420	✓	24 (3x8)	✓		✓	✓	✓	✓	✓	✓	✓
3616	✓	6	✓		✓	✓	✓	✓	✓	✓	✓
3620	✓	6	✓		✗	✗	✗	✗	✓	✓	✓
3626	✓	6	✓		✓	✓	✓	✓	✓	✓	✓
3641	✓	12	✓		✗	✗	✗	✗	✗	✓	✓
3645	✓	12	✓		✗	✗	✗	✗	✗	✓	✓
3701	✗	0	✗	—	✗	✗	✗	✓	✓	✓	✓
3711	✗	0	✗	—	✗	✗	✗	✓	✓	✓	✓
3810	✓	4	✓		✓	✓	✓	✓	✓	✓	✓
4406D	✓	6	✓		✓	✓	✓	✓	✓	✓	✓
4412D	✓	24	✓		✓	✓	✓	✓	✓	✓	✓
4424D	✓	24	✓		✓	✓	✓	✓	✓	✓	✓
4601	✓	2	✓		✗	✗	✓	✓	✓	✓	✓
4602IP/SW	✓	2	✓		✓	✓	✓	✓	✓	✓	✓
4606	✓	6	✓		✓	✓	✓	✓	✓	✗	✗
4610SW	✓	24 (4x6)	✓		✗	✗	✓	✓	✓	✓	✓
4612	✓	12	✓		✓	✓	✓	✓	✓	✗	✗
4620	✓	24 (2x12)	✓		✓	✓	✓	✓	✓	✓	✓
4621	✓	24 (2x12)	✓		✗	✗	✗	✓	✓	✓	✓
4624	✓	24	✓		✓	✓	✓	✓	✓	✗	✗
4625	✓	24 (2x12)	✓		✓	✓	✓	✓	✓	✓	✓
5402	✓	2 (+12)	✓		✗	✗	✓	✓	✓	✓	✓
5410	✓	12 (2x6)	✓		✗	✗	✓	✓	✓	✓	✓
5420	✓	24 (3x8)	✓		✓	✓	✓	✓	✓	✓	✓
5601	✓	2	✓		✗	✗	✓	✓	✓	✓	✓
5602IP/SW	✓	2	✓		✗	✗	✓	✓	✓	✓	✓
5610SW	✓	24 (4x6)	✓		✗	✗	✓	✓	✓	✓	✓
5620	✓	24 (2x12)	✓		✗	✗	✓	✓	✓	✓	✓
5621	✓	24 (2x12)	✓		✗	✗	✗	✗	✓	✓	✓
6408D	✓	8	✓		✓	✓	✓	✓	✓	✓	✓
6416D	✓	16	✓		✓	✓	✓	✓	✓	✓	✓
6424D	✓	24	✓		✓	✓	✓	✓	✓	✓	✓
9040	✓	8 (2x4)	✓		✓	✓	✓	✓	✓	✗	✗
T3 Compact	✓	4	✗		✗	✗	✗	✓	✓	✓	✓
T3 Classic	✓	10	✗		✗	✗	✗	✓	✓	✓	✓
T3 Comfort	✓	18	✗		✗	✗	✗	✓	✓	✓	✓
T3 IP Compact	✓	4	✗		✗	✗	✗	✗	✓	✓	✓
T3 IP Classic	✓	10	✗		✗	✗	✗	✗	✓	✓	✓
T3 IP Comfort	✓	18	✗		✗	✗	✗	✗	✓	✓	✓

- A number of phones only have two physical programmable buttons. On systems running IP Office 3.0 or higher (excluding 3.0DT) these button should only be used as call appearance buttons.
- The 2402 and 5402 phones have an additional 12 programmable slots that can be accessed by pressing **FEATURE**. These cannot be used for appearance actions.

Call Appearance Buttons

Call Appearance Buttons

Call appearance buttons are used to display alerts for incoming calls directed to a user's extension number or to a hunt group of which they are a member. Call appearance buttons are also used to make outgoing calls.

By having several call appearance buttons, a user is able to be alerted about several calls, select which call to answer, switch between calls and take other actions.

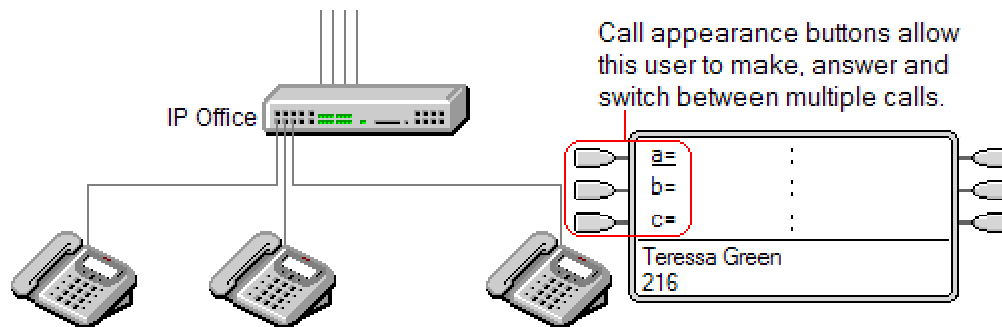

When all the user's call appearance buttons are in use or alerting, any further calls to their extension number receive busy treatment. Instead of busy tone, the user's forward on busy is used if enabled or otherwise voicemail if available.

Call appearance buttons are the primary feature of key and lamp operation. None of the other appearance button features can be used until a user has some call appearance button programmed.

There are also additional requirements to programming call appearance buttons:

- Call appearance buttons must be the first button programmed for the user, followed by any further call appearance buttons in a continuous block.
- Programming a single call appearance button for a user is not supported. The normal default is 3 call appearances per user except on phones where only two physical buttons are available.

Reserving a Button for Outgoing Calls

On phones using call appearance buttons, a free call appearance is required to complete function such as call transfers. Through an entry into the user's configuration settings, their last call appearance button can be reserved for making outgoing calls only. This is done by entering **RESERVE_LAST_CA=** into the user's **Source Number** tab within IP Office Manager.

Call Appearance Example 1

In this example, the user has multiple call appearance buttons.

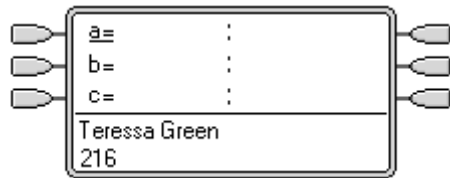

- 1. Phone Idle**
The phone is currently idle.

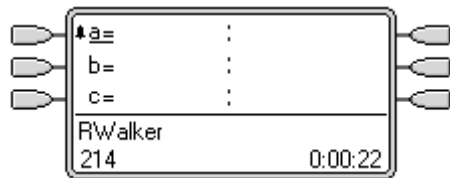

- 2. First Call Alerts**
A call arrives. It alerts against the first available call appearance button. Pressing that button will answer the call.

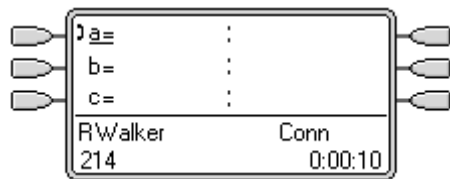

- 3. Call Answered**
The call is now connected.

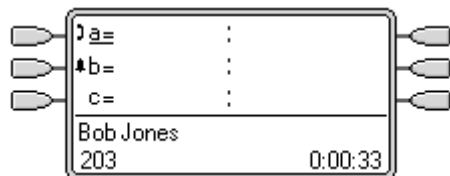

- 4. Second Call Alerts**
A second call arrives whilst the first is still connected. It alerts against the next available call appearance button. As the user has a call in progress, the alert gives just a single ring and briefly display details of the caller.

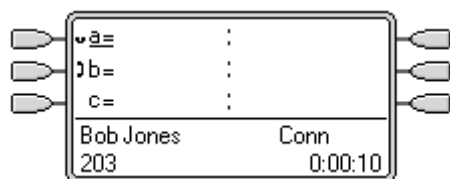

- 5. Pressing the Second Call Appearance**
Pressing the second call appearance button will hold the first call and answer the second.

Call Appearance Example 2

In this example, the user will use their call appearances to make two calls and start a conference between those calls.

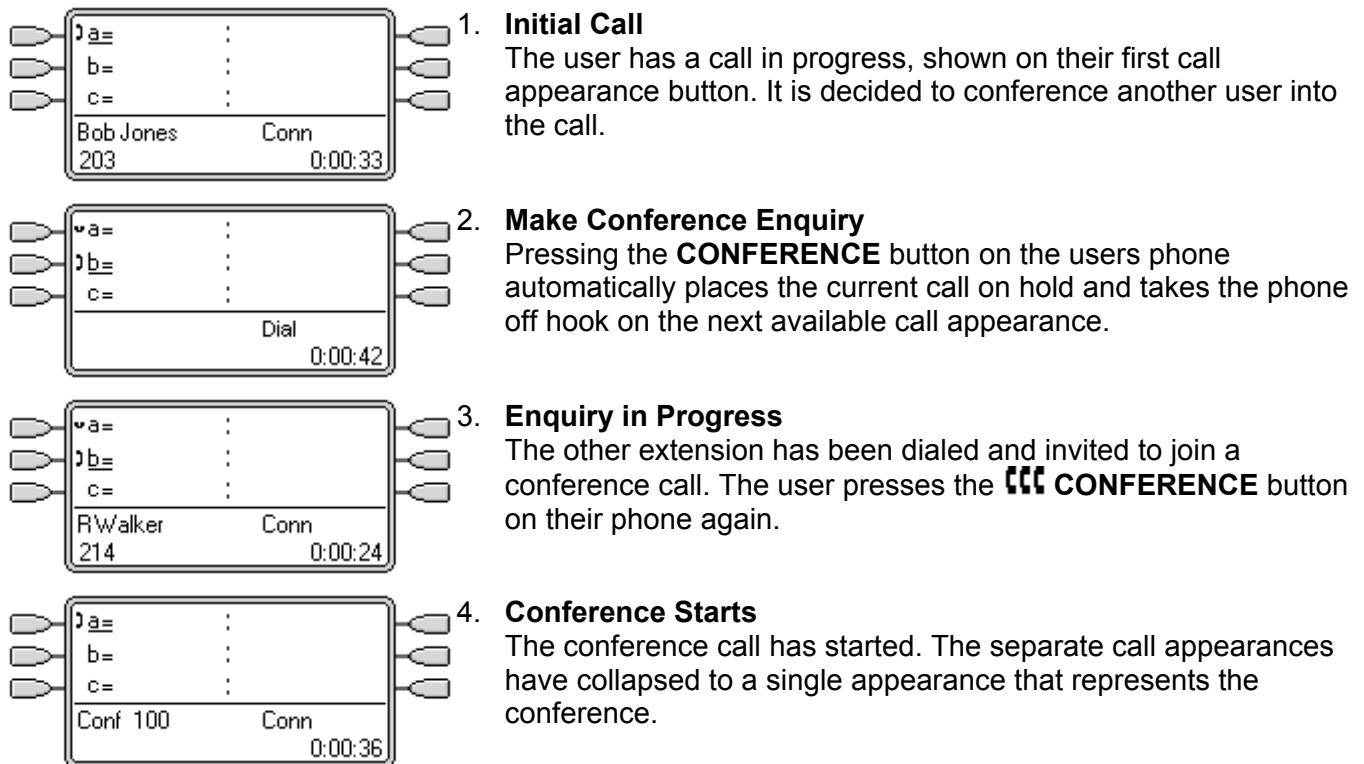

How are Call Appearance Buttons Treated?

For incoming calls

- **Call Waiting** settings are ignored except for hunt group call waiting where the call waiting tone is replaced by an alert on a call appearance button if available.
- **Follow Me, Forward Unconditional** and **Forward Hunt Group Calls** are used when set.
- If **Do Not Disturb** is set, only calls from numbers in the user's Do Not Disturb Exception list will alert if a call appearance is available.
- External calls arriving on a line for which the user also has a line appearance set, will only alert on the line appearance button.

Busy status

- **For calls direct to the user's extension number:**
The user is busy when all their available call appearances are in use. Instead of busy tone, the user's forward on busy is used if enabled or otherwise voicemail if available.
- **For calls to a hunt group of which the user is a member:**
The user is busy to further hunt group calls when they have any appearance button in use on their phone.
- In both cases above, even when busy, the user may still receive alerts on other appearance buttons; for example call coverage, line appearance and bridged appearance buttons.

For outgoing calls

- Outgoing calls are treated exactly the same as calls made by non-appearance button users.
- External Calls made on a call appearance, which route out on a line for which the user also has a line appearance, will remain on the call appearance. The line appearance will indicate 'in use elsewhere'.

For call appearance buttons matched by a bridged appearance button

- If the bridged appearance is used to make or answer calls, the state of the call appearance will match that of the bridged appearance.
- If the call is put on hold by the bridged appearance user, the call appearance will show 'on hold elsewhere'.

Other









- **Held/Parked Call Timeout**
If the user has parked a call, the parked call timer only starts running when the user is idle rather than on another call.
- Incoming calls routed directly to the user as the incoming call routes destination on a line for which the user also has a line appearance, will only alert on the line appearance. These calls do not follow any forwarding set but can be covered.

Call Appearance Button Indication

On phones with a text display area next to the button, by default **a=**, **b=** and so on is displayed. This can be replaced by another label if required.

When the user is not connected to a call, the button indicated as selected is the button that will be used if the user goes off hook without pressing an appearance button. When a user is connected to a call, that call is the selected button.

The following table shows how the different states of call appearance buttons (alerting, held, etc) are indicated. This is a general table, not all phone button types are covered. The ring that accompanies the visual indication can be delayed or switched off. See Ring Delay.

5410/5420	4400 Series	Call Appearance Button State
CA1		Idle The call appearance is not in use and is not currently selected.
CA1		Idle + Selected The call appearance is not in use but is the current selected button that will be used if the user goes off hook.
* CA1 Flashing icon.		Alerting The matching call appearance is alerting for an incoming call. This is accompanied by ringing. If the user is already on a call, only a single ring is given.
* CA1 Flashing icon.		Alerting + Selected As above but Ringing Line Preference has made this the user's current selected button.
⌋ CA1		In Use Here The user has a call connected on the call appearance or is dialing.
⌋ CA1		In Use Elsewhere The call appearance button is in use on a bridged appearance.
⌋ CA1		On Hold Here The call has been put on hold by this user.
⌋ CA1		On Hold Elsewhere A call on a bridged appearance button matched to the call appearance has been put on hold. Calls on a call appearance that are put on hold by another user will continue to show connected lamp status, though the phone display will indicate a held call.
⌋ CA1 Icon flashes off.		Inaccessible The button pressed is not accessible. The call is still dialing, ringing or cannot be bridged into. A single tone is also given.

Call Coverage Buttons

Call Coverage Appearance Buttons

Call coverage allows a user to be alerted when another user has an unanswered call.

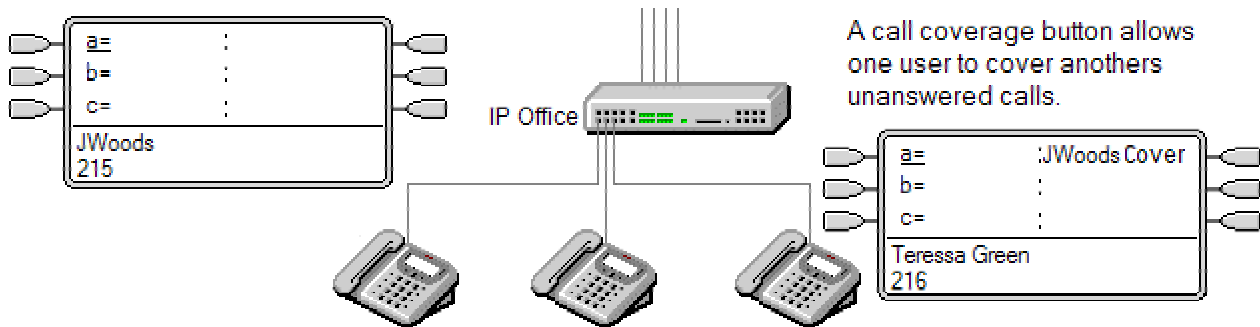

The user being covered does not necessarily have to be a key and lamp user or have any programmed appearance buttons. Their Individual Coverage Time setting (default 10 seconds) sets how long calls will alert at their extension before also alerting on call coverage buttons set to that user.

The user doing the covering must have appearance buttons including a call coverage appearance button programmed to the covered user's name.

- Note: Call coverage has been supported from IP Office 1.3. However the method of programming and operation has changed with IP Office 3.0. Users of pre-3.0 IP Office systems that used call coverage should refer to "Upgrading from Pre 3.0 IP Office".

Call coverage appearance buttons are not supported between users on different systems in a Small Community Network.

Call Coverage Example 1

In this example, the covering user is able to answer their colleagues call when it rings unanswered. Both users have **Ringing Line Preference** and **Auto Hold** on.

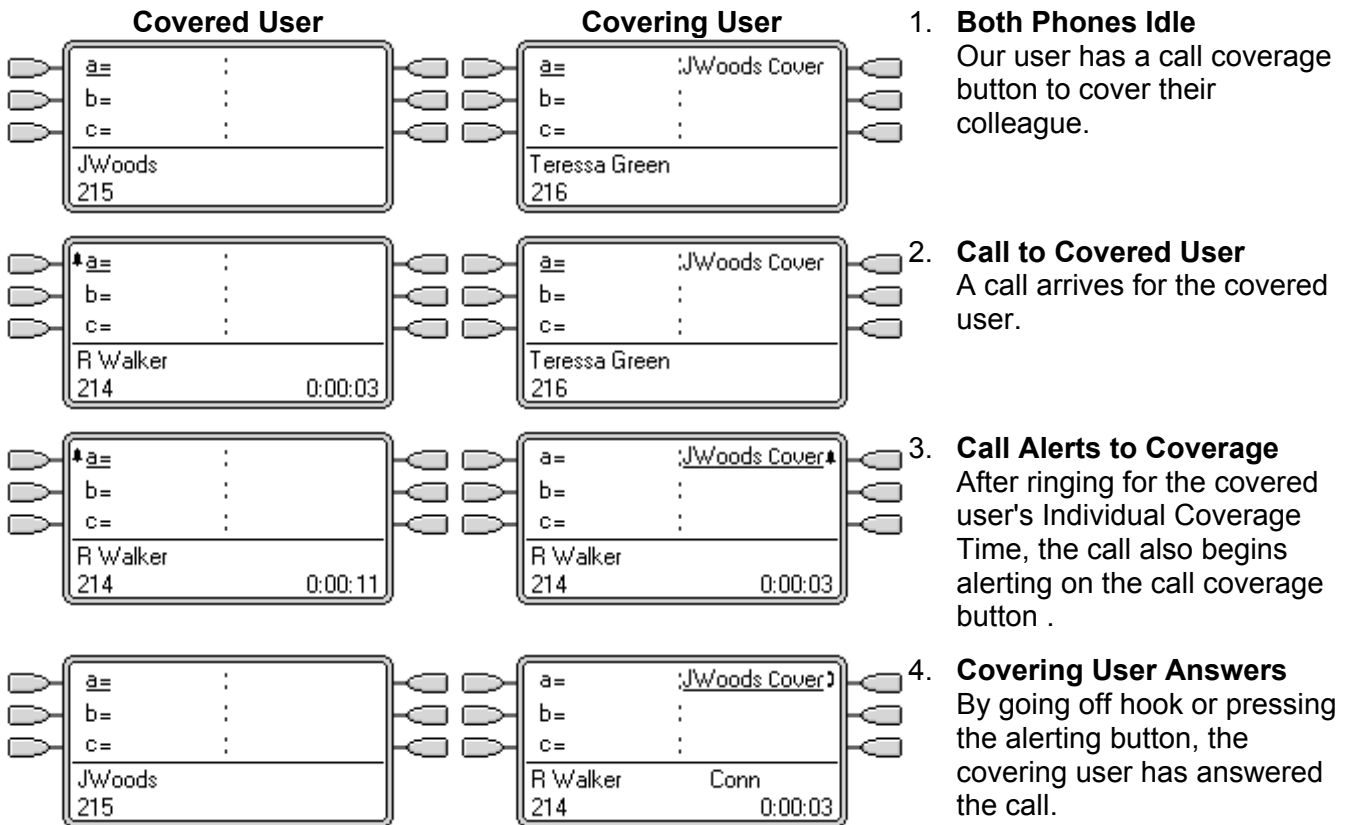

Call Coverage Example 2

In this example, the covered user has calls on all their available call appearances. Both users have **Ringing Line Preference** and **Auto Hold** on.

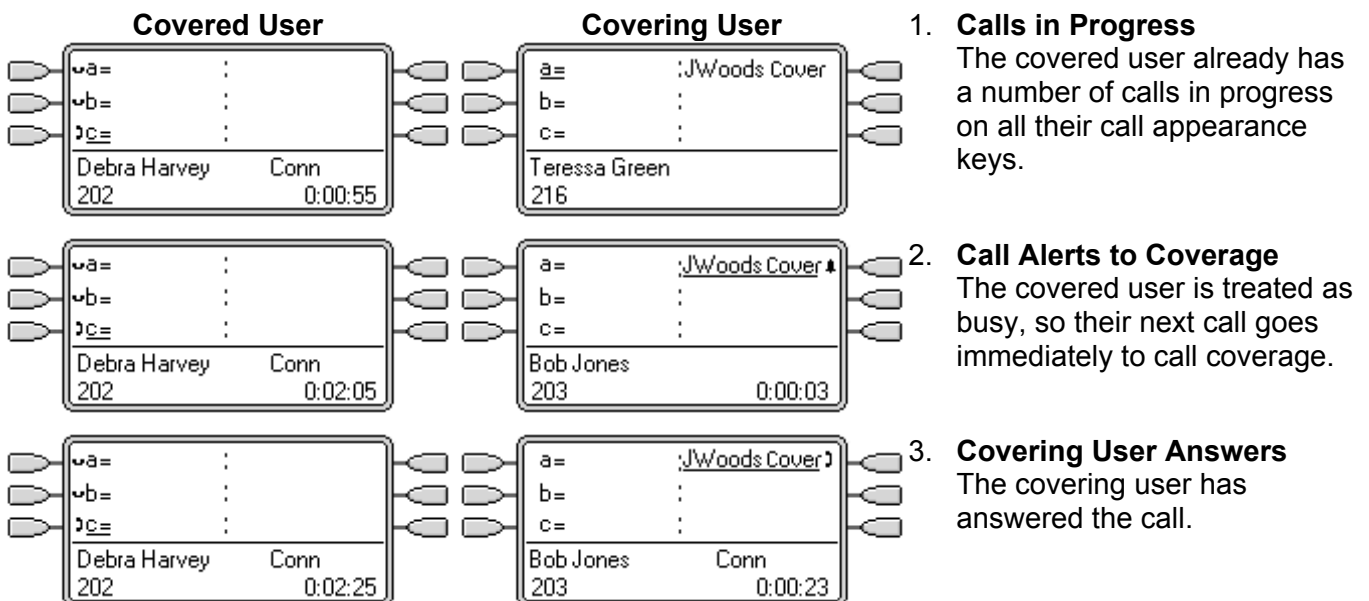

How is Call Coverage Treated?

Whose user settings control the call?

- Until answered, calls alerting on a call coverage button follow the settings of the user to which the call was originally directed.
- Once answered, the call follows the user settings of the user who answered it.

Coverage is applied to:

- Internal calls dialed to the covered user's extension number.
- External calls routed to the covered user by an IP Office incoming call route.
- Calls forwarded internally by the covered user or on follow me from the covered user.

Coverage is not applied to:

- Hunt group calls to a hunt group of which the covered user is a member.
- Calls forwarded to the covered user using forward or follow me functions.
- Calls alerting on the covered user's bridged appearance and call coverage buttons.
- Coverage is only applied to calls alerting on a line appearance if the call was also routed to that user by an incoming call route.
- Page and intercom calls.
- Parked, transferred and held calls ringing back to the user.
- Automatic callback calls set by the covered user.
- Voicemail ringback calls.
- Call coverage appearance buttons are not supported between users on different systems in a Small Community Network.

Coverage is applied:

- If the covered user's phone is available, call coverage is applied only after the covered user's Individual Coverage Time has expired.
- If the covered user's phone is busy, call coverage is applied immediately.
- If the covered user is using follow me or forward all to an internal number to divert their calls, call coverage is still applied.
- If the covered user has 'do not disturb' on, call coverage is applied immediately except for calls from numbers in the covered user's do not disturb exceptions list.

Other items:





- If the call is not answered after the covered user's **No Answer Time** it will go to the covered user's voicemail if available or follow their forward on no answer settings.
- If the covered user has several alerting calls, the call answered by the call coverage button is the covered user's longest ringing call.
- Calls will not alert at a covering user who has 'do not disturb' enabled, except when the calling number is in the covering user's do not disturb exception list.

Call Coverage Button Indication

On phones with a text display area next to the button, the name of the covered user is displayed followed by the word **Cover**.

When the user is not connected to a call, the button indicated as selected is the button that will be used if the user goes off hook without pressing an appearance button. When a user is connected to a call, that call is the selected button.

The following table shows how the different states of call coverage appearance buttons (alerting, held, etc) are indicated. This is a general table, not all phone button types are covered. The ring that accompanies the visual indication can be delayed or switched off. See Ring Delay.

<u>5410/5420</u>	<u>4400 Series</u>	<u>Call Coverage Button State</u>
JWoods Cover		Idle The button is not in use.
‡ JWoods Cover Flashing icon.		Alerting The call coverage is alerting for an unanswered call at the covered user's phone. This is accompanied by ringing. If the user is already on a call, only a single ring is given.
‡ JWoods Cover Flashing icon.		Alerting + Selected As above but Ringing Line Preference has made this the user's current selected button.
‡ JWoods Cover		In Use Here The user has answered the call requiring coverage.
‡ JWoods Cover		On Hold Here The covered call has been put on hold by the call coverage button user.

Bridged Appearance Buttons

Bridged Appearance Buttons

A bridged appearance button shows the state of one of another user's call appearance buttons. It can be used to answer or join calls on that user's call appearance button. It can also be used to make a call that the call appearance user can then join or retrieve from hold.

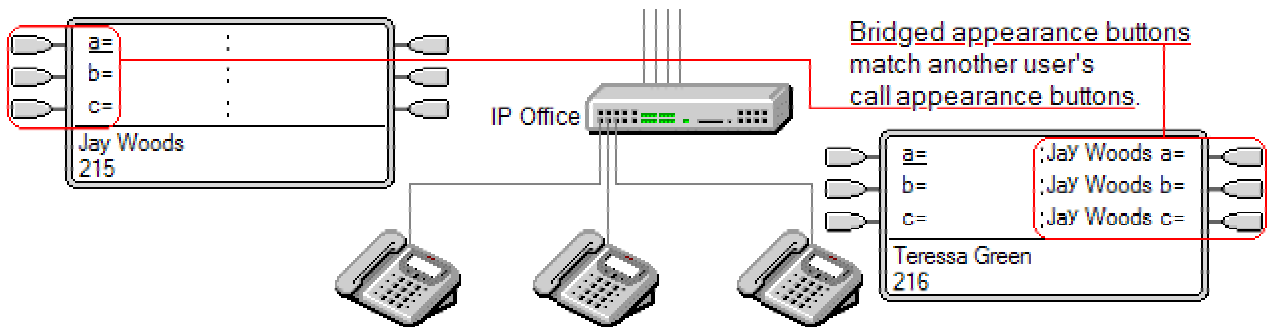

- When the user's call appearance button alerts, any associated bridged appearance buttons on other user's phones also alert. The bridged appearance buttons can be used to answer the call on the call appearance button user's behalf.
- When the call appearance button user answers or makes a call, any associated bridged appearance buttons on other users' phones show the status of the call, ie. active, on hold, etc. The bridged appearance button can be used to retrieve the call if on hold or to join the call if active (subject to intrusion permissions).
- **Note:**
Bridged appearance buttons are different from the action of bridging into a call (joining a call). See Joining Other Calls (Bridging).

Bridged appearance buttons are not supported between users on different systems in a Small Community Network.

Bridged Appearance Example 1

In this example, one user is able to see the status of the other user's call appearances, and when necessary answer calls for the other user. Both users have **Ringling Line Preference** and **Auto Hold** on.

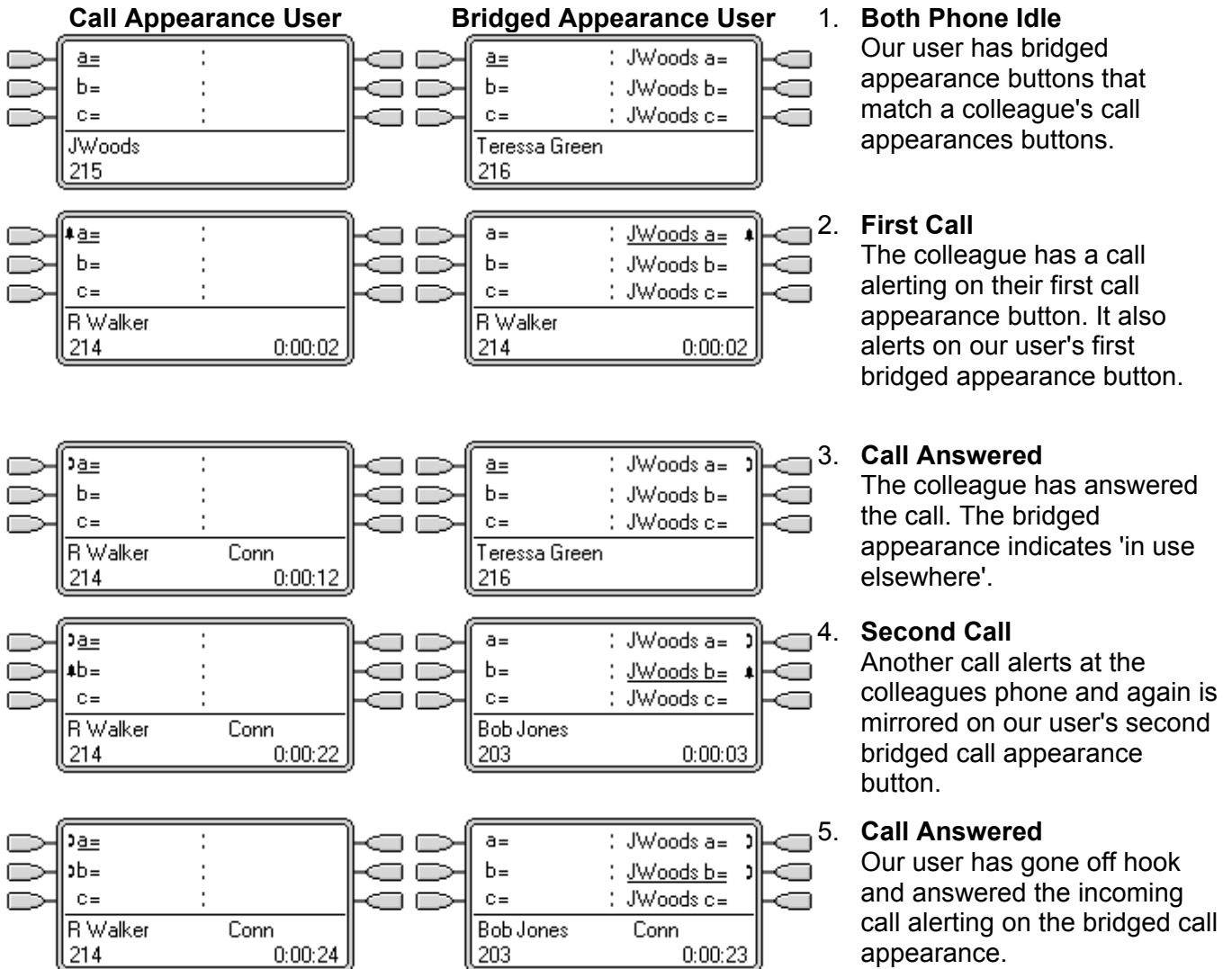

Bridged Appearance Example 2

In this example, the bridged appearance user makes a call on behalf of the call appearance user. Once the call is connected, they put it on hold. The call appearance user is able to take the call off hold using their call appearance button. Both users have **Ringing Line Preference** and **Auto Hold** on.

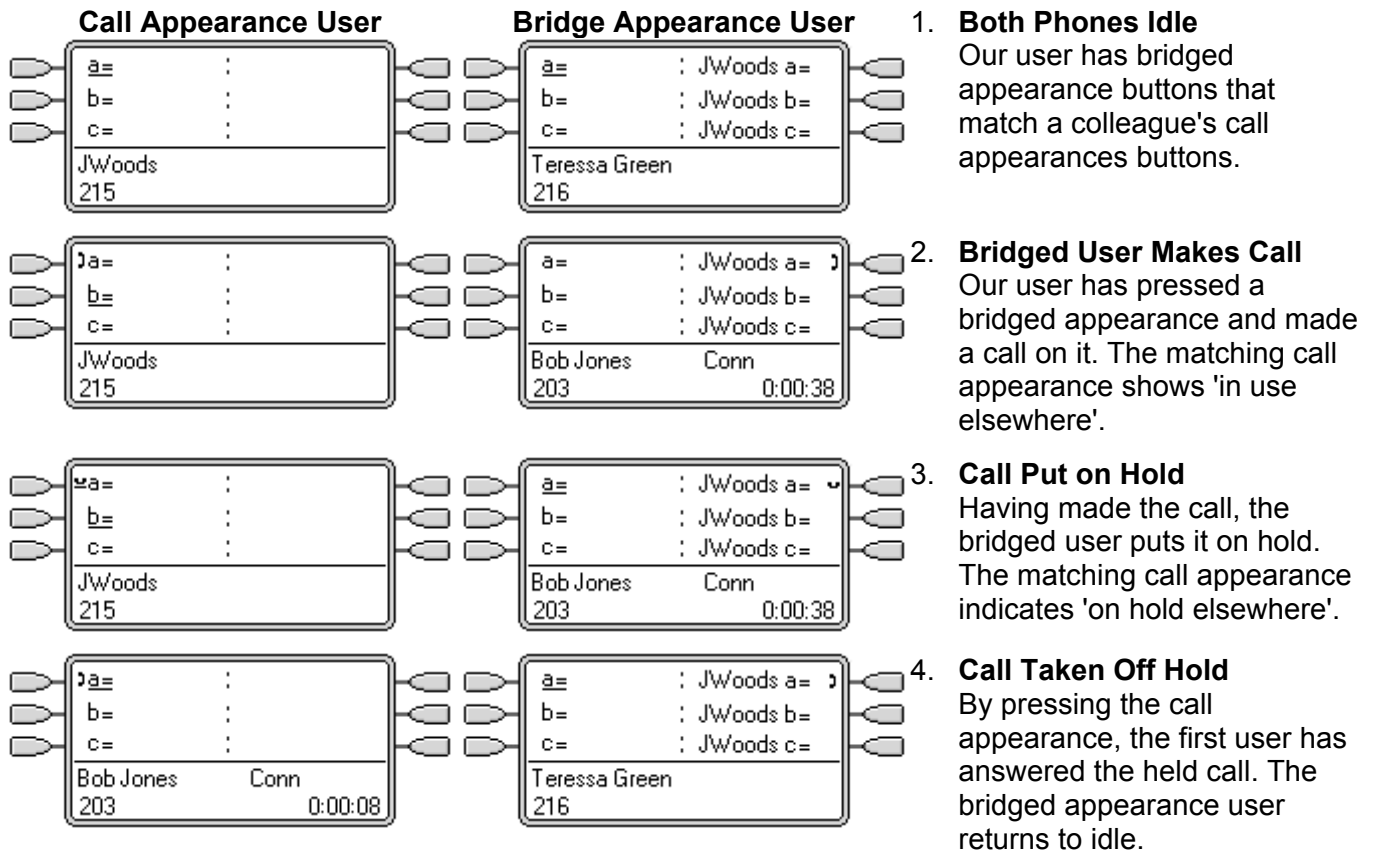

Bridged Appearance Example 3

In this example, a call is passed from the call appearance user to the bridged appearance user. Both users have **Ringing Line Preference** and **Auto Hold** on.

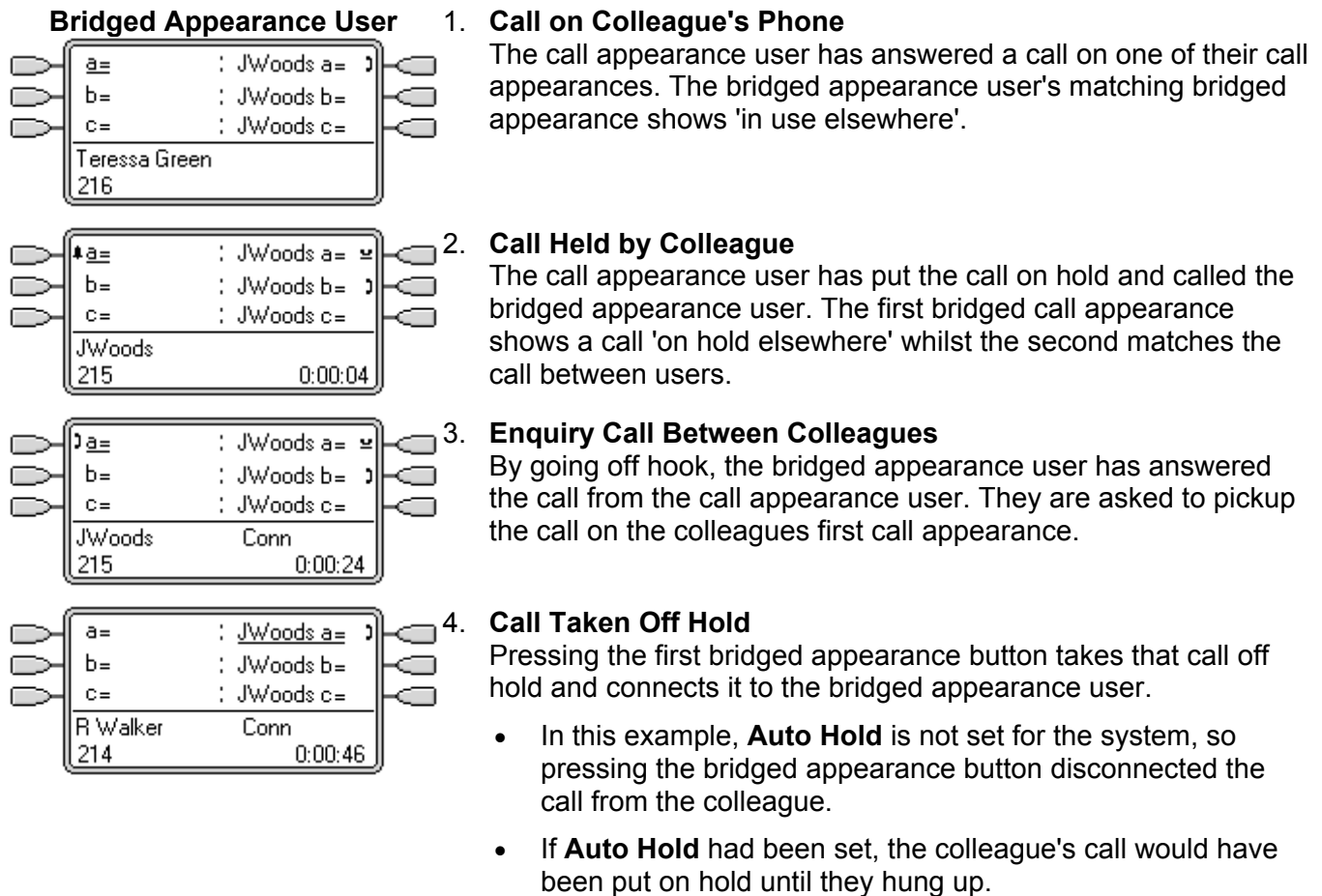

How are Bridged Appearances Treated?

Bridged appearance buttons operate in parallel with their matching call appearance button.

- **Whose user settings control the call?**

Until answered on a bridged appearance button, calls alerting on a bridged appearance button follow the settings of the user or hunt group to which the call was originally directed.









- If the call appearance is in use, any matching bridged appearance will indicate the same.
- If a bridged appearance is in use, the call appearance it matches will indicate the same.
- The bridge appearance will only alert if the call appearance is alerting. For example, direct intercom and paging call to the call appearance will show on the bridged appearance but will not give any audible alert.
- If the bridged appearance user put the call on hold, the call appearance will indicate 'on hold elsewhere'.
- Bridged appearances to a user who has logged off, or has logged onto a non-multi line phone, will not operate.
- If the bridged appearance user has 'do not disturb' (DND) enabled, the bridge appearance button icon or lamps will still operate but alerting and ringing line preference selection are not applied unless the caller is in their DND exception list.

Bridged appearance buttons are not supported between users on different systems in a Small Community Network.

Bridged Appearance Button Indication

On phones with a text display area next to the button, the name of the bridged user and the label from the bridged user's call appearance key are displayed.

The following table shows how the different states of bridged appearance buttons (alerting, held, etc) are indicated. This is a general table, not all phone button types are covered. The ring that accompanies the visual indication can be delayed or switched off. See Ring Delay.

5410/5420	4400 Series	Bridge Appearance Button State
JWoods CA1	 Red off, Green off.	Idle The bridged appearance is not in use.
*JWoods CA1 Flashing icon.	 Red off, Green steady flash.	Alerting The matching call appearance is alerting for an incoming call. This is accompanied by ringing. If the user is already on a call, only a single ring is given.
*JWoods CA1 Flashing icon.	 Red on, Green steady flash.	Alerting + Selected As above but Ringing Line Preference has made this the user's current selected button.
JWoods CA1	 Red off, Green on.	In Use Elsewhere The matching call appearance button is in use.
JWoods CA1	 Red on, Green on.	In Use Here The user has made a call or answered a call on the bridged appearance, or bridged into it.
JWoods CA1	 Red off, Green fast flash.	On Hold Here The call has been put on hold by this user.
JWoods CA1	 Red off, Green intermittent flash.	On Hold Elsewhere The call on that call appearance has been put on hold by another user.
*JWoods CA1 Icon flashes off.	 Red off, Green broken flash.	Inaccessible The button pressed is not accessible. The call is still dialing, ringing or cannot be bridged into. A single tone is also given.

Line Appearance Buttons

Line Appearance Buttons

Line appearance buttons allow specific individual line to be used when making calls or answered when they have an incoming call. It also allows users to bridge into calls on a particular line.

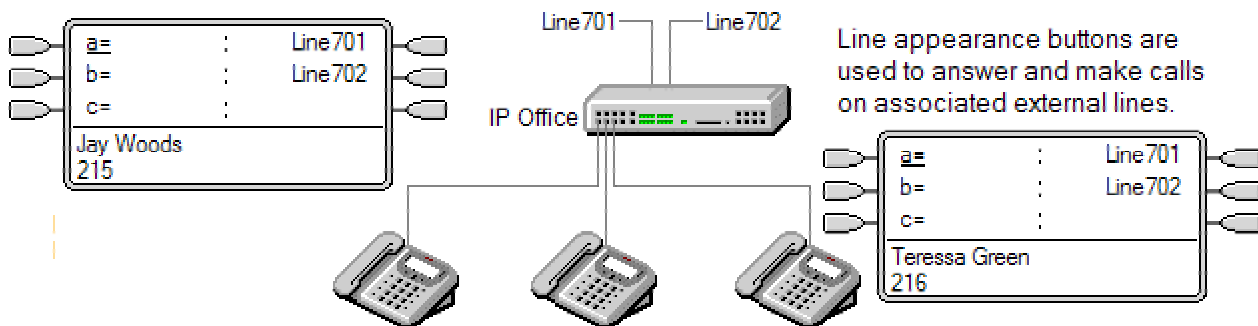

IP Office incoming call routing is still used to determine the destination of all incoming calls. Line appearance buttons allow a call on a specific line to alert the button user as well as the intended call destination. When these are one and the same, the call will only alert on the line appearance but can still receive call coverage.

When alerting on suitable phones, details of the caller and the call destination are shown during the initial alert.

IP Office 3.0+ allows individual line appearance ID numbers to be assigned to selected lines on an IP Office system. Line appearance buttons are only supported for analog, E1 PRI, T1, T1 PRI, and BRI PSTN trunks; they are not supported for other trunks including E1R2, QSIG and IP trunks.

Line appearance buttons are not supported for lines on remote systems in a Small Community Network.

- **Using Line Appearances for Outgoing Calls**

In order to use a line appearance to make outgoing calls, changes to the normal external dialing short codes are required. For full details see [Outgoing Line Programming](#).

- **Private Lines**

Special behaviour is applied to calls where the user has both a line appearance for the line involved and is also the Incoming Call Route destination of that call. Such calls will alert only on the Line Appearance button and not on any other buttons. These calls will also not follow any forwarding.

Line Appearance Example 1

In this example, the user is able to answer a call alerting on a particular line.

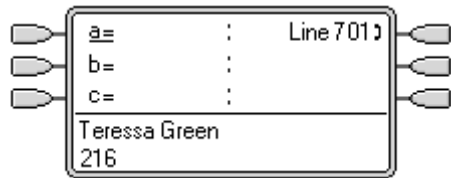

1. Line Goes Active

A call is active on the line with line ID number 601. This is indicated as 'in use elsewhere'.

- For an incoming call, the line will show active but will not alert until call routing has been determined. On analog ICLID lines, alerting is delayed until the ICLID that might be used to do the call routing has been received.

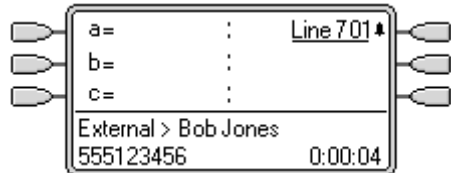

2. Line Appearance Alerting

The routing of the call has been complete and it is ringing against its destination. On our user's phone the line appearance also alerts and ringing line preference has made it the current selected button.

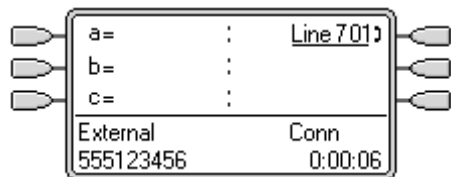

3. Answer Call

By going off hook or pressing the line appearance, our user has answered the call on that line.

Line Appearance Example 2

In this example, two users exchange a call using line appearance buttons set to the same line. Note that this requires that the user who first answers the call to have **Cannot be Intruded** off. Both users have **Ringing Line Preference** and **Auto Hold** on.

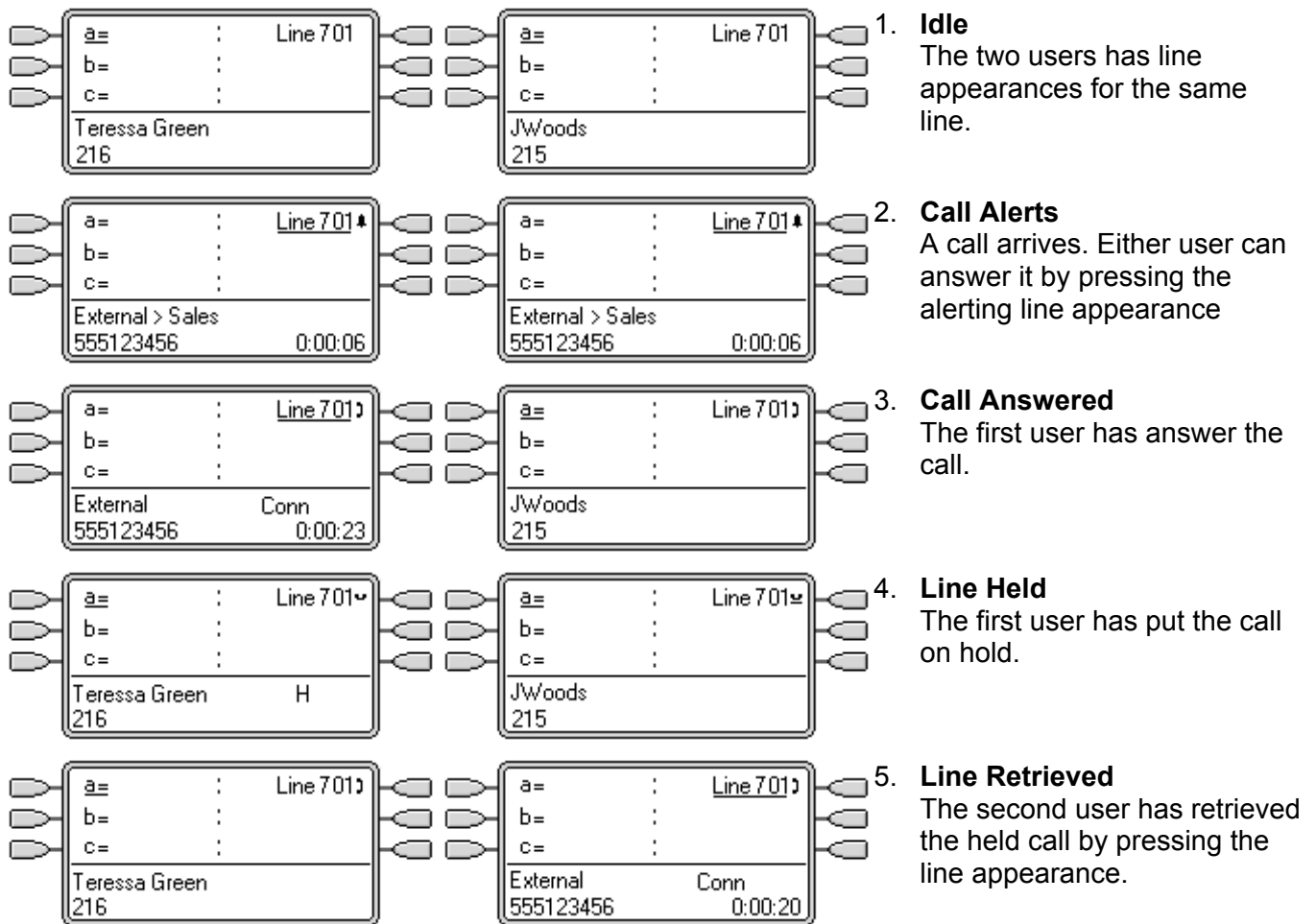

How are Line Appearances Treated?

Incoming Calls

- **Until answered using a line appearance button, incoming calls alerting on a line appearance, follow the settings of the incoming call route's destination group or user. They do not follow the settings of any line appearance user.**
- If an incoming call's destination is voicemail, or once the incoming call has passed from its destination to voicemail, it cannot be answered or bridged into using a line appearance button.
- If the line appearance user is also the incoming call route's destination, the call will alert on their line appearance only. In this case:
 - It will alert on the line appearance even if all call appearances are in use.
 - The call will not follow any of the user's forwarding settings.
 - The call will receive call coverage from other users with call coverage buttons set to the line appearance user.
 - The ring delay used is that of the first free call appearance.
- For analog lines set to ICLID, any line appearances show active while the IP Office waits for ICLID information. During this time the line has not been routed and cannot be answered using a line appearance button.
- Calls alerting on a line appearance can also alert on a call coverage appearance on the same phone. If Ringing Line Preference is set, the current selected button will change from the line appearance to the call coverage appearance.
- If the line appearance user has do not disturb (DND) enabled, the line appearance button icon or lamps will still operate but alerting and ringing line preference selection are not applied unless the caller is in their DND exception list.

Outgoing Calls

- In order to be used for making outgoing calls, some additional system programming may be required. See Outgoing Line Programming.
- Calls made on a call appearance, which are routed out on a line for which the user also has a line appearance, will remain on the call appearance. The line appearance will indicate 'in use elsewhere'.

Additional Notes









- Calls alerting on a line appearance do not receive call coverage unless the user was the call's original incoming call route destination.
- If a call indicated by a line appearance is parked, it cannot be joined or unparked by using another line appearance.
- Where a line appearance button is used to answer a call for which automatic call recording is invoked, the recording will go to the automatic recording mailbox setting of the original call destination.
- Line appearance buttons are not supported for lines on remote systems in a Small Community Network.

Line Appearance Button Indication

On phones with a text display area next to the button, the label **Line** and the line number are displayed.

When the user is not connected to a call, the button indicated as selected is the button that will be used if the user goes off hook without pressing an appearance button. When a user is connected to a call, that call is the selected button.

The following table shows how the different states of line appearance buttons (alerting, held, etc) are indicated. This is a general table, not all phone button types are covered. The ring that accompanies the visual indication can be delayed or switched off. See Ring Delay.

<u>5410/5420</u>	<u>4400 Series</u>	<u>Line Appearance Button State</u>
Line 601		Idle The associated line is not in use.
Line 601		Idle + Selected The associated line is not in use but the button is the user currently selected button.
*Line 601 Flashing icon.		Alerting The line is ringing at it incoming call route destination. This is accompanied by ringing. If the user is already on a call, only a single ring is given.
*Line 601 Flashing icon.		Alerting + Selected As above but Ringing Line Preference has made this the user's current selected button.
]Line 601		In Use Elsewhere The line is in use.
]Line 601		In Use Here The user has answered the line, made a call on it or bridged into the call on the line.
∩Line 601		On Hold Here The call on the line has been put on hold by this user.
∩Line 601		On Hold Elsewhere The call on the line has been put on hold by another appearance button user.
∩Line 601 Icon flashes off.		Inaccessible The button pressed is not accessible. The call is still dialing, ringing, routing or cannot be bridged into. A single tone is also given.

- For systems running the IP Office 4.0 Q2 2007 maintenance release or higher, the default label of Line and line appearance ID can be replace by the Line Name or Channel Name. Refer to the **SHOW_LINEID_NOT_OUTSIDE** within the IP Office Manager documentation.

Other Appearance Controls

Summary

This section covers the following topics:

- **Selected Button Indication**
- **Idle Line Preference**
- **Ringling Line Preference**
- **Answer Pre-Select**
- **Auto Hold**
- **Ring Delay**
- **Collapsing Appearances**
- **Joining Other Calls (Bridging)**
- **Multiple Alerting Buttons**
- **Busy on Held**
- **Reserving a Call Appearance Button**
- **Logging Off and Hot Desking**
- **IP Office Applications**

Selected Button Indication

During appearance button usage, one of the user's appearance buttons may be indicated as the user's current selected button. This is the appearance button already in use, or if idle, the appearance button that will be used if the user goes off hook by lifting the handset.

- On phones with a display area next to each button, the current selected button is indicated by either an `_` underscore of the button label or a `*` star.

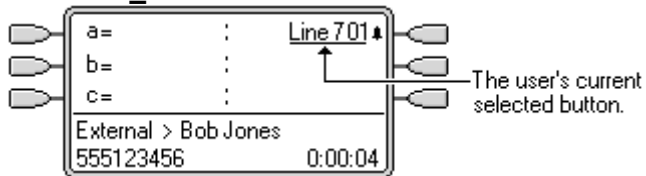

- On phones with twin LED lamps, the current selected button is indicated by the red lamp being on .
- On Transtalk 9040 phones, the current selected button is indicated by a `◀` icon.

The IP Office sets which appearance button is the current selected button using the following methods:

- Idle Line Preference**
This feature can be set on or off for each individual user, the default is on. When on, it sets the current selected button as the first available idle call appearance or line appearance button. See Idle Line Preference.
- Ringling Line Preference**
This feature can be set on or off for each individual user, the default is on. When on, it sets the current selected button as the button which has been alerting at the users phone for the longest. Ringling Line Preference overrides Idle Line Preference. See Ringling Line Preference.
- Delayed Ring Preference: 4.0+.**
This setting is used in conjunction with ringling line preference and appearance buttons set to delayed or no ring. It sets whether ringling line preference should observe or ignore the delayed ring applied to the user's appearance buttons when determining which button should have current selected button status.
- User Selection**
The phone user can override both Idle Line Preference and Ringling Line Preference by pressing the appearance button they want to use or answer. That button will then remain the current selected button whilst active.
 - If the user currently has a call connected, pressing another appearance button will either hold or disconnect that call. The action is determined by the IP Office system's **Auto Hold** setting.
 - Answer Pre-Select: 4.0+**
Normally when a user has multiple alerting calls, only the details of the call on current selected button are shown. Pressing any of the alerting buttons will answer the call on that button, going off-hook will answer the current selected button. Enabling the user telephony setting **Answer Pre-Select** allows the user to press any alerting button to make it the current selected button and displaying its call details without answering that call. To answer a call when the user has **Answer Pre-Select** enabled, the user must press the alerting button to display the call details and then either press the button again or go off-hook.

Idle Line Preference

Idle Line Preference determines the user's currently selected button as the first available idle call appearance or line appearance button. Selected button indication is applied to that button and if the user goes off-hook, for example by lifting their handset, an outgoing call is started on that button.

- **Idle Line Preference** is overridden by **Ringing Line Preference** if also on for the user.
- By default **Idle Line Preference** is on for all users.
- For appearance button users with **Idle Line Preference** off, going off-hook (lifting the handset or pressing **SPEAKER**, **HEADSET**, etc) will have no effect until an appearance button is pressed.
- If all the available call appearance and line appearance buttons are in use, no current selected button choice is made by **Idle Line Preference**. In this case, going off hook will have no effect.
- **?Why Would I Use Just Idle Line Preference**
In environments that are focused on making outgoing calls, for example telemarketing, incoming calls are infrequent and user's go off-hook expecting to make a call. Using **Idle Line Preference** without **Ringing Line Preference** ensures that the user doesn't inadvertently answer a call when expecting to make a call.

Idle Line Preference Example 1

In this example, only **Idle Line Preference** has been programmed for the user. **Ringing Line Preference** has not been programmed. The user has three call appearance buttons and one line appearance button programmed.

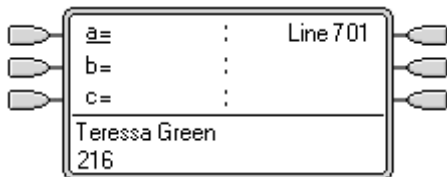

1. Phone Idle

The phone is idle. The current selected button determined by Idle Line Preference is the first available idle call appearance button. This is shown by the _ underscore of the button text.

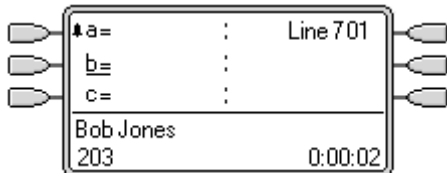

2. First Call to User

A call for the user arrives. It alerts on the first available call appearance button. Idle Line Preference has changed the current selected button to the next available idle call appearance.

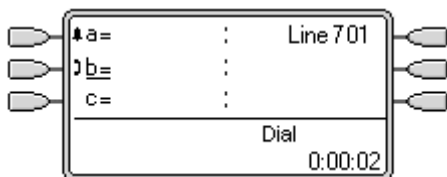

3. User Goes Off Hook

With the call still alerting, if the user goes off hook, it will be interpreted as making a call using the currently selected button, not as answering the alerting button.

4. To answer the alerting call, the user should press the alerting button.

Idle Line Preference Example 2

In this example, only **Idle Line Preference** has been programmed for the user. **Ringing Line Preference** has not been programmed. The user has three call appearance buttons and one line appearance button programmed.

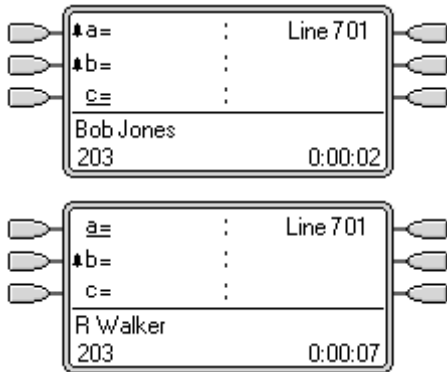

1. **Two Calls Alerting**
The users has two incoming calls alerting. Idle Line Preference has set the currently selected button to their third call appearance.
2. **First Caller Abandons**
If the first incoming caller disconnects, the currently selected button changes to the first call appearance as this is now the first available idle call or line appearance button.

Idle Line Preference Example 3

In this example, only **Idle Line Preference** has been programmed for the user. **Ringing Line Preference** has not been programmed. The user has three call appearance buttons and one line appearance button programmed.

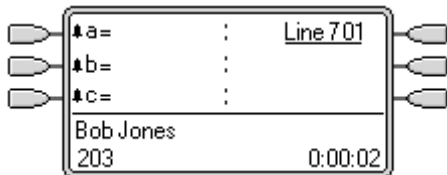

1. **All Call Appearances Alerting**
In this case, all the users call appearance buttons are alerting incoming calls. Idle Line Preference has changed the currently selected button to the first available line appearance.

Idle Line Preference Example 4

In this example, both **Idle Line Preference** and **Ringing Line Preference** are set for the user.

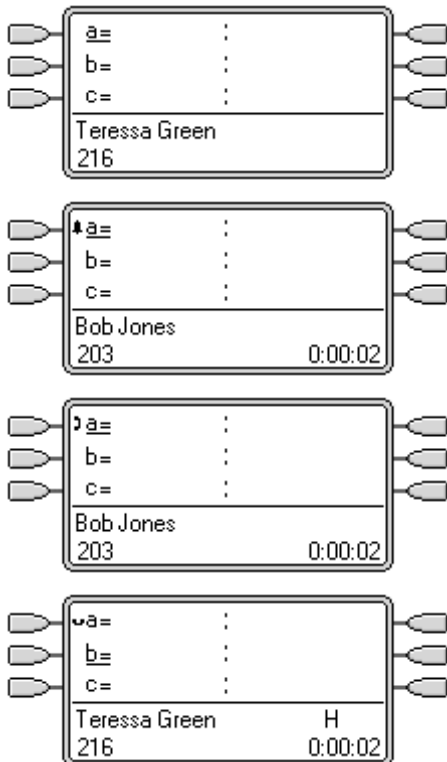

1. **Phone Idle**
The phone is idle and **Idle Line Preference** has assigned current selected button to the first call appearance.
2. **Call Alerting**
A call has arrived and **Ringing Line Preference** keeps the current selected button at the first call appearance.
3. **Call Answered**
With the call answered it retains current selected button status.
4. **Call Held**
When the call is put on hold, **Idle Line Preference** assigns current selected button status to the next available call appearance button.

Ringling Line Preference

Ringling Line Preference determines the user's currently selected button as the button which has been alerting the longest. Selected button indication is applied to that button and if the user goes off-hook, for example by lifting their handset, the alerting call on that button is answered.

Ringling Line Preference includes calls alerting on call appearance, line appearance, bridged appearance and call coverage buttons.

- **Ringling Line Preference** overrides **Idle Line Preference**.
- By default **Ringling Line Preference** is on for all users.
- **Ringling Line Preference Order**
When a user's longest waiting call alerts on several of the user's appearance buttons and Ringling Line Preference is set for the user, the order used for current selected button assignment is;
 1. Call appearance.
 2. Bridged appearance.
 3. Call coverage.
 4. Line appearance.
- **Example:**
A user has a call to a covered user alerting initially on a line appearance button. Ringling Line Preference assigns current selected button status to the line appearance. When the same call also begins to alert on the call coverage appearance button, current selected button status switches to the call coverage appearance button.
- **Ring Delay and Ringling Line Preference**
For IP Office 3.2 and higher appearance buttons can be set to **Delayed Ring** or **No Ring**. These buttons still alert visually but do not give an audible ring or tone. Ringling line preference is still applied to alerting buttons even if set to **Delayed Ring** or **No Ring**.
 - **Delayed Ring Preference**
For IP Office 4.0 and higher, for users with Ringling Line Preference selected, their **Delayed Ring Preference** setting sets whether ringling line preference is uses or ignores buttons that are visually alerting but have **Delayed Ring** or **No Ring** set. The default is off, ie. ignore ring delay.

Ringing Line Preference Example 1

In this example, both **Ring Line Preference** and **Idle Line Preference** have been set for the user. The user has three call appearance buttons and one line appearance button programmed. They also have **Ringing Line Preference** on and **Auto Hold** is on. **Answer Pre-Select** is off.

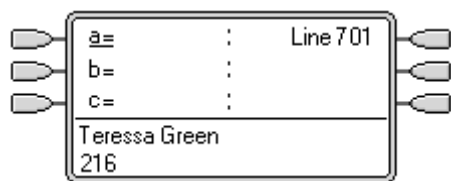
- 

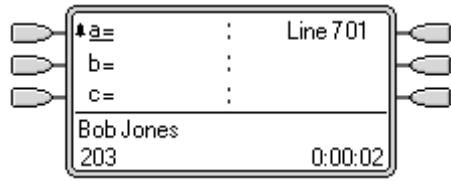
1. **Phone Idle**
The phone, an IP Office 5420, is idle. The current selected button has been determined by Idle Line Preference as the first available idle call appearance button. This is shown by the _ underscore next to that button.
- 

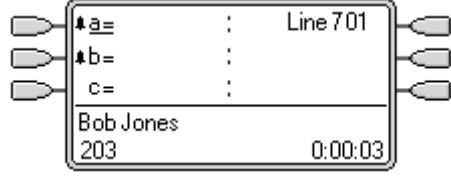
2. **First Call Alerting**
A call for the user arrives. It alerts on the first available call appearance button. Ringing Line Preference uses this as the currently selected button as it is the only alerting call.
- 

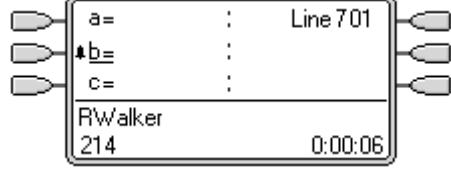
3. **Second Call Alerting**
Another call for the user arrives. It alerts on the next available call appearance button. As the first call has been alerting longer, under Ringing Line Preference it retains the currently select button status.
- 

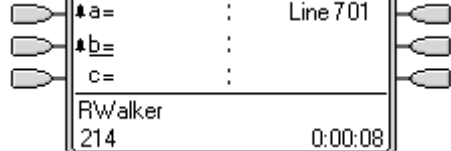
4. **The First Call Abandons**
The first caller disconnects. Ringing Line Preference changes the currently selected button status to the second call appearance button.
- 

5. **Another Call Arrives**
Another call arrives. It alerts as the first free call appearance button. However the call at the second call appearance has been alerting longer and so under Ringing Line Preference retain the currently selected button status.

Ringing Line Preference Example 2

In this example, the user has both Ring Line Preference and Idle Line Preference programmed. The user has three call appearance buttons and one line appearance button programmed. They also have **Ringing Line Preference** on and **Auto Hold** is on. **Answer Pre-Select** is off.

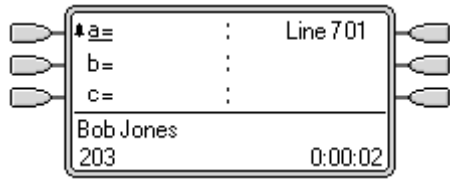

1. First Call to User

A call for the user arrives. It alerts on the first available call appearance button. Ringing Line Preference uses this as the currently selected button as it is the only alerting call.

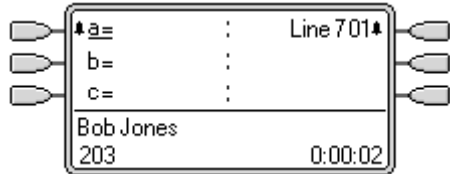

2. Call on Line 601

The user's Line Appearance is alerting due to an incoming call on the associated line. Details of the call and its destination are shown. Ringing Line Preference keeps the currently selected button status on the call appearance button as this has been alerting longest.

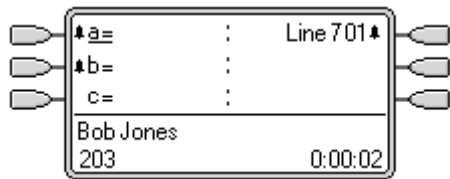

3. Second Call to User

A second call to the user arrives and alerts on the second call appearance button. Ringing Line Preference keeps the currently selected button status on the call appearance button as this has been alerting longest.

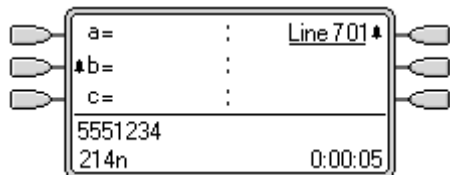

4. The First Caller Abandons

The first call to the user disconnects. Ringing Line Preference passes the currently selected button status to the Line Appearance button as this has been alerting longest.

Answer Pre-Select

On some phones only the details of the call alerting or connected on the current selected button are shown. The details of calls alerting on other buttons are only shown briefly when they are first presented and are then replaced again by the details of the call on the current selected button.

By default pressing any of the other alerting buttons will answer the call on that button. IP Office 4.0+ supports Answer Pre-Select which can be set individually for each user. Answer pre-select allows a user to press alerting buttons other than the current selected button without actually answering them. Instead the button pressed becomes the current selected button and its call details are displayed.

Note that using answer pre-select with a currently connected call will still either hold or end that call in accordance with the IP Office system's **Auto Hold** setting.

Answer Pre-Select Example 1

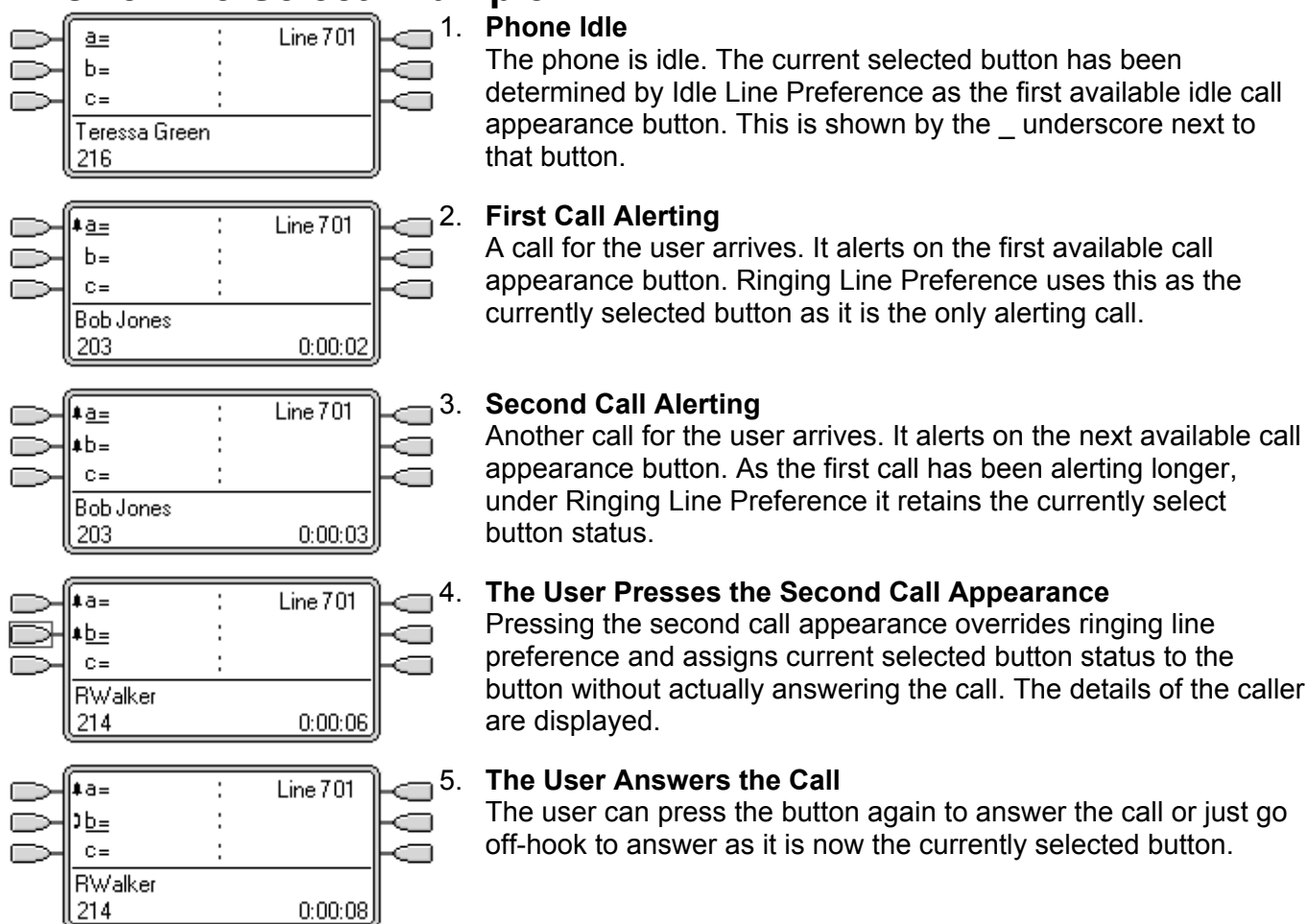

Auto Hold

Auto Hold is a system wide feature that affects all appearance button users. This feature determines what happens when a user, who is already on a call, presses another appearance button. The options are:

- If **Auto Hold** is **off**, the current call is disconnected.
- If **Auto Hold** is **on**, the current call is placed on hold.

On IP Office 4.0 and higher systems **Auto Hold** is **on** by default. On previous levels of IP Office software the default for US was **off**.

Auto Hold Example 1

In this example, the user has two calls currently shown on call appearance buttons. **Answer Pre-Select** is off.

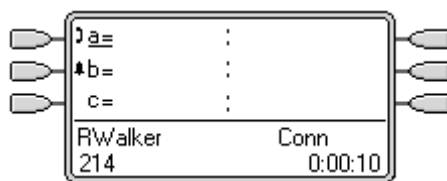

1. This user has three call appearance buttons. They have answer one call and are still connected to it, shown by the ☎ icon. A second call is now alerting on their second call appearance button, shown by the ⚡ icon.
2. What happens when the user presses the second call appearance key is determined by the IP Office system's **Auto Hold** setting:



- **Auto Hold On**
When the second call appearance key is pressed, that call is answered and the first call is put on hold, shown by the ⚡ icon. The user can switch between calls using the call appearance buttons and make/receive other calls if they have additional call appearance buttons
- **Auto Hold Off**
When the second call appearance key is pressed, that call is answered and the first call is disconnected.



Ring Delay

IP Office systems running IP Office 3.2+ software support the option of ring delay on appearance buttons. This option can be used with all types of appearance buttons and can be selected separately for each appearance button a user has. Using ring delay does not affect the buttons visual alerting through the display, and display icons or button lamps.

Ring delay is typically used with line appearance buttons for lines which a user wants to monitor but does not normally answer. However ring delay can be applied to any type of appearance button.

The selectable ring delay options for an appearance button are listed below. The option is selected as part of the normal button programming process.

- **Immediate**
Provide audible alerting as per normal IP Office operation.
- **Delayed Ring**
Only provide audible alerting after the system ring delay or, if set, the individual user's ring delay.
- **No Ring**
Do not provide any audible alerting.

There are two possible sources for the delay used when delayed ringing is selected for a button.

- **System | Telephony | Ring Delay:** *Default = 5 seconds, Range 1 to 98 seconds.*
This is the setting used for all users unless a specific value is set for an individual user.
- **User | Telephony | Ring Delay:** *Default = Blank (Use system setting), Range 1 to 98 seconds.*
This setting can be used to override the system setting. It allows a different ring delay to be set for each user.

Notes

- **Calls That Ignore Ring Delay**
Ring delay is not applied to hold recall calls, park recall calls, transfer return calls, voicemail ringback calls and automatic callback calls. For phones using Internal Twinning, ring delay settings are not applied to calls alerting at a secondary twinned extension (except appearance buttons set to No Ring which are not twinned).
- **Auto Connect Calls**
For IP Office 3.2 and 4.0, auto-connected calls such as Internal Auto-Answer override Ring delay. For IP Office 4.1+, ring delay is applied to these calls before auto-connection. This does not apply to page calls.
- **Multiple Alerting Buttons**
Where a call is presented on more than one button on a user's phone, see Multiple Alerting Buttons, the shortest delay will be applied for all the alerting buttons. For example, if one of the alerting buttons is set to **Immediate**, that will override any alerting button set to **Delayed Ring**. Similarly if one of the alerting buttons is set to **No Ring**, it will be overridden if the other alerting button is set to **Immediate** or **Delayed Ring**.
- **Line Appearance Buttons**
Calls routed to a user that could potentially be presented on both a call appearance button and a line appearance button are only presented on the line appearance button. However in this scenario, the ring delay settings used is that of the first free call appearance button.
- **Delay on Analog Lines**
Analog lines set to Loop Start ICLID already delay ringing whilst the IP Office waits for the full ICLID in order to resolve incoming call routing. In this scenario the ring delay operates in parallel to the routing delay.
- **Ring Delay and Ringing Line Preference**
For IP Office 3.2 and higher appearance buttons can be set to **Delayed Ring** or **No Ring**.

However ringing line preference is still applied to alerting buttons even if set to **Delayed Ring** or **No Ring**.

- For IP Office 4.0 and higher, the user's **Delayed Ring Preference** setting is used to determine whether ringing line preference is used with or ignores buttons that are alerting but have **Delayed Ring** or **No Ring** set.

Ring Delay Example 1

In this example, the user has a line appearance button set but configured to no ring.

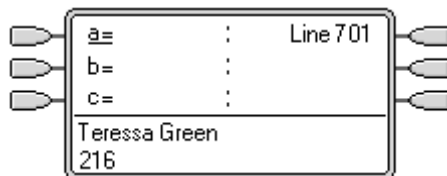

1. Phone Idle

The phone is idle. The current selected button has been determined by Idle Line Preference as the first available call appearance button. This is shown by the _ underscore next to that button.

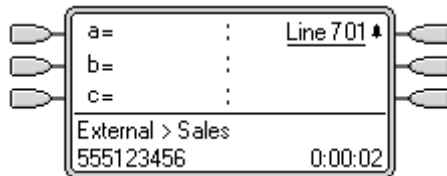

2. Incoming Call Alerting on the Line

An incoming call arrives on the line and begin to alert somewhere on the system. The user's line appearance button shows this visually but doesn't ring audibly. Ringing line preference would make the line appearance the user's currently selected button and therefore they would answer the line if they went off-hook.

Delayed Ring Preference

When a call is alerting at a phone, Ringing Line Preference sets the call as the currently selected button and if the user then goes off-hook they will answer that call.

In most situations this is acceptable as the user hears ringing which informs them that there is a call waiting to be answered. If the user wants to make a call instead they can press another call appearance button to go off-hook on that other button.

When ring delay is being used there can potentially be a problem if the user lifts the handset to make a call without looking at the display. If they do this while the a call is alerting silently on a button with ring delay, the user will actually answer the waiting call rather than get dial tone to make a call.

Once the call alerting on a button has currently selected call status, it retains that status even if a prior call on a button with ring delay applied comes out of its ring delay period.

Delayed Ring Preference Example 1

In this example the user has a line appearance button for a line they monitor. This line appearance button has been set to no ring as the user occasionally need to use that line but does not normally answer calls on that line.

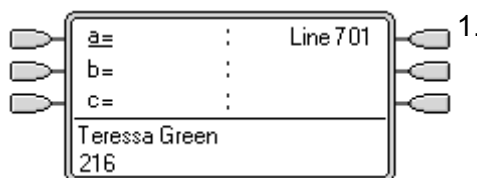

1. **Phone Idle**

The phone is idle. The current selected button has been determined by Idle Line Preference as the first available call appearance button. This is shown by the _ underscore next to that button.

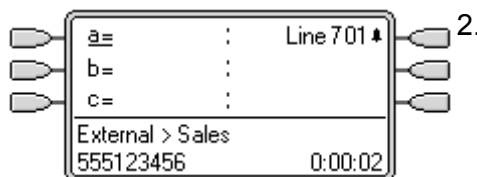

2. **Incoming Call Alerting on the Line**

An incoming call arrives on the line and begin to alert somewhere on the system. The user's line appearance button shows this visually but doesn't ring audibly.

- Normally ringing line preference would make the line appearance the user's currently selected button and therefore they would answer the line if they went off-hook expecting to make a call.
- However, because **Delayed Ring Preference** is on for the user, ringing line preference is not applied and idle line preference makes their current selected button the first call appearance. If the user were to go off-hook they would be making a call on that call appearance.

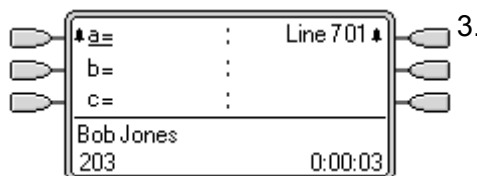

3. **Call Alerting for the User**

A call for the user arrives. It alerts on the first available call appearance button. Ringing line preference is applied and makes that the users currently selected button. If the user goes off-hook now that will answer the call on the call appearance and not the line appearance.

Delayed Ring Preference Example 2

This is similar to the previous example except that the user and the line has been configured for a 15 second ring delay. This informs the users that the line has not been answered for some reason and allows them to answer it by just going off-hook.

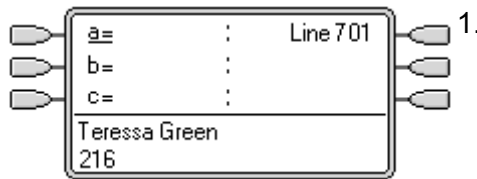

1. Phone Idle

The phone is idle. The current selected button has been determined by Idle Line Preference as the first available call appearance button. This is shown by the _ underscore next to that button.

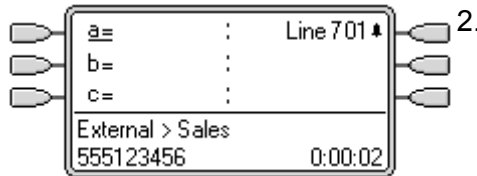

2. Incoming Call Alerting on the Line

An incoming call arrives on the line and begin to alert somewhere on the system. The user's line appearance button shows this visually but doesn't ring audibly. Because **Delayed Ring Preference** is on for the user, ringing line preference is not applied and idle line preference makes their current selected button the first call appearance. If the user were to go off-hook they would be making a call on that call appearance.

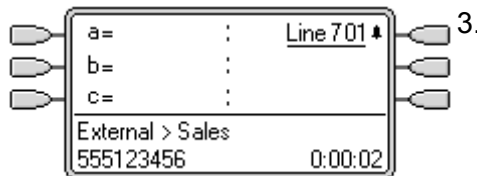

3. Call Continues Alerting

When the ring delay for the line appearance expires, if no other call has taken ringing line preference it becomes the current selected call and will be answered if the user goes off-hook.

Collapsing Appearances

This topic covers what happens when a user with several calls on different appearance buttons, creates a conference between those calls. In this scenario, the call indication will collapse to a single appearance button and other appearance buttons will return to idle except for any line appearance buttons involved which will show 'in use elsewhere'.

Collapsing Appearances Example 1

In this example, the user will setup a simple conference. **Ringing Line Preference** and **Idle Line Preference** are set for the user. **Auto Hold** for the system is on. **Answer Pre-Select** is off.

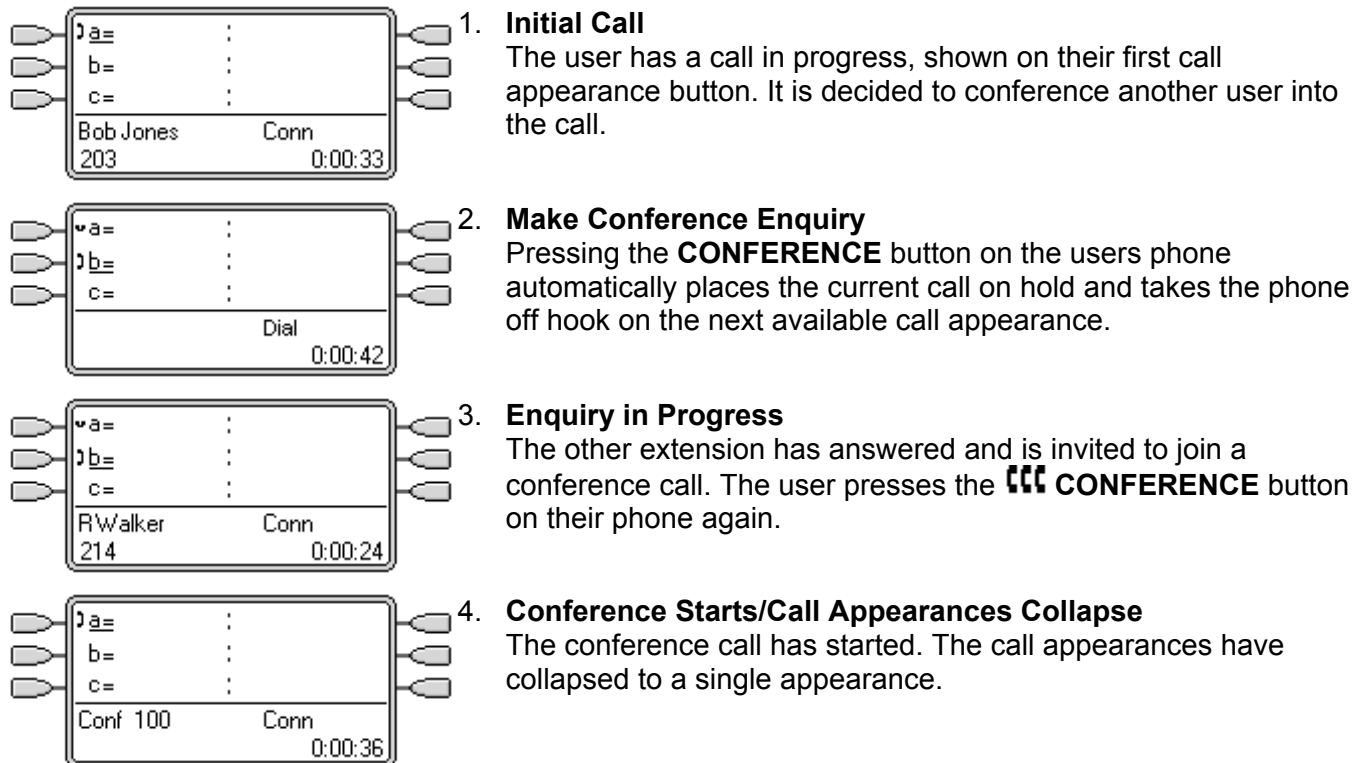

Joining Calls (Bridging)

Appearance buttons can be used to "join" existing calls and create a conference call. A user can join calls that are shown on their phone as 'in use elsewhere'. These can be on bridged and/or line appearances.

- This feature is often referred to as 'bridging into a call'. However this causes confusion with Bridged appearance buttons and so the term should be avoided.

The ability to join calls is controlled by the following feature which can be set for each IP Office user:

- **Cannot be Intruded:** *Default = On*

If this option is set on for the IP Office user who has been in the call the longest, no other user can join the call. If that user leaves the call, the status is taken from the next internal user who has been in the call the longest. The exceptions are:

- Voicemail and Conferencing Center calls are treated as **Cannot be Intruded** at all times.
- When an external call is routed off switch by a user who then leaves the call, the **Cannot be Intruded** status used is that of the user who forwarded the call off switch.
- Any call that does not involve an internal user at any stage is treated as **Cannot be Intruded** on. For example:
 - When an external call is routed off switch automatically using a short code in the incoming call route.
 - Small Community Network calls from other IP Offices that are routed off-switch.
 - VoIP calls from a device not registered on the IP Office.
- The **Can Intrude** setting is not used for joining calls using appearance buttons.

The following also apply:

- **Inaccessible**

In addition to the use of the **Cannot be Intruded** setting above, a call is inaccessible if:

- The call is still being dialed, ringing or routed.
- It is a ringback call, for example a call timing out from hold or park.
- If all the internal parties, if two or more, involved in the call have placed it on hold.

- **IP Office Conferencing Resources**

The ability to bridge depends on the available conferencing resource of the IP Office system. Those resources are limited and will vary with the number of existing parties in bridged calls and conferences. The possible amount of conferencing resource depends on the IP Office system type and whether IP Office Conferencing Center is also installed.

- **Conference Tone**

When a call is joined, all parties in the call hear the IP Office conferencing tones. By default this is a single tone when a party joins the call and a double-tone when a party leaves the call. This is a system setting.

- **Holding a Bridged Call**

If a user puts a call they joined on hold, it is their connection to the joined call (conference) that is put on hold. The other parties within the call remain connected and can continue talking. This will be reflected by the button status indicators. The user who pressed hold will show 'on hold here' on the button they used to join the call. All other appearance users will still show 'in use here'.

- **Maximum Two Analog Trunks**

Only a maximum of two analog trunks can be included in a conference call.

- **Parked Calls**

A Line Appearance button may indicate that a call is in progress on that line. IP Office 4.0 and higher allows such calls to be unparked using a line appearance.

Joining Example 1: Joining with a Line Appearance

In this example, the user joins a call by pressing a line appearance button. **Answer Pre-Select** is off.

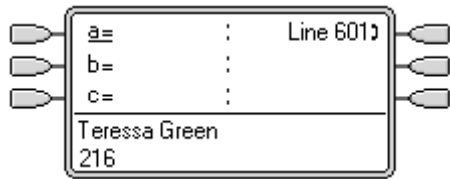

1. Line Goes Active

A call is active on the line with line ID number 601.

- If this is an incoming call, it will show active but will not alert until its call routing has been determined. On ICLID analog lines, alerting is delayed until the ICLID that might be used to do that routing has been received.

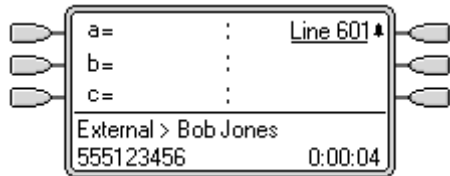

2. Line Appearance Alerting

The call routing is completed and the call is now ringing against its target. The line appearance also begins alerting and Ringing Line Preference has made it the current selected button.

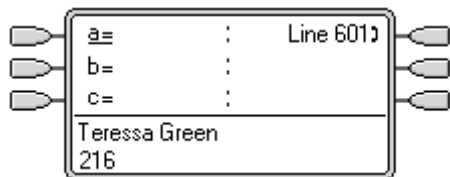

3. Call Answered

Alerting on the line appearance has stopped but the line is still active. This indicates that the call has probably been answered. As our user's phone is idle, Idle Line Preference has returned the current select button to the first available call appearance button.

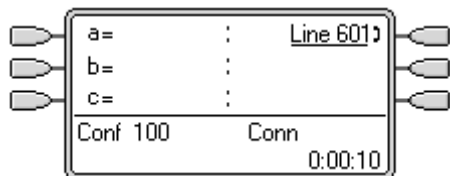

4. User Joins the Call

Our extension user has been asked by their colleague to join the call just answered on line 601. By pressing the line appearance button they have joined the call on that line and created a conference call.

Joining Example 2: Joining with a Bridged Appearance

In this example, the user joins a call using a bridged appearance button. **Answer Pre-Select** is off.

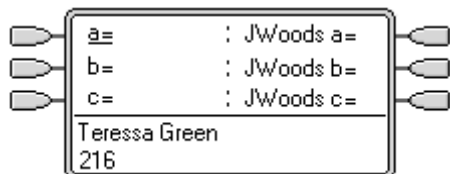

1. User with Bridged Appearance Buttons

The user has bridged appearance buttons that match their colleagues call appearance buttons.

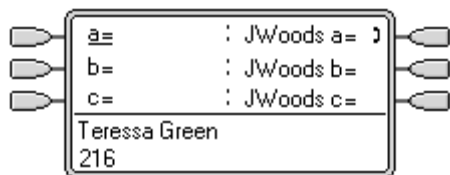

2. Call on Bridged Appearance

The colleague has a call in progress on their first call appearance. This is matched on the first bridged appearance button.

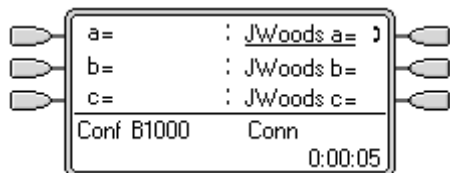

3. User Joins the Call

Pressing the bridged appearance button will take our user off hook and join them into their colleagues call, creating a conference call.

Multiple Alerting Appearance Buttons

In some scenarios, it may be potentially possible for the same call to alert on several appearance buttons. In this case the following apply:

- **Line appearance buttons override call and bridged appearance buttons:**
In cases where a call on a line goes directly to the user as the incoming call routes destination, the call will only alert on the line appearance. In this scenario the ring delay settings used is that of the first free call appearance button.
- **A call can alert both call appearance, line appearance and bridged appearance buttons:**
The most common example of this will be hunt group calls where the hunt group members also have bridged call appearances to each other. In this case the button used to answer the call will remain active whilst the other button will return to idle.
- **Calls on a line or bridged appearance buttons can also alert on call coverage button:**
In this case alerting on the call coverage button may be delayed until the covered user's Individual Coverage Time has expired.
- **Ringling Line Preference Order**
When a call alerts on several of the user's appearance buttons and **Ringling Line Preference** is set for the user, the order used for current selected button assignment is:
 1. Call appearance.
 2. Bridged appearance.
 3. Call coverage.
 4. Line appearance.
- **Example:**
A user has a call to a covered user alerting initially on a line appearance button. **Ringling Line Preference** will assign current selected button status to the line appearance. When the same call also begins to alert on the call coverage appearance button, current selected button status switches to the call coverage appearance button.

Ring Delay

Where ring delays are being used, the shortest delay will be applied for all the alerting buttons. For example, if one of the alerting buttons is set to **Immediate**, that will override any alerting button set to **Delayed Ring**. Similarly if one of the alerting buttons is set to **No Ring**, it will be overridden if the other alerting button is set to **Immediate** or **Delayed Ring**.

Twinning

Twinning is a mechanism that allows an IP Office to have their calls alert at two phones. The user's normal phone is referred to as the primary, the twinned phone as the secondary.

By default only calls alerting on the primary phone's call appearance buttons are twinned. For internal twinning, IP Office 4.1+ supports options to allow calls alerting on other types of appearance buttons to also alert at the secondary phone. These options are set through the **User | Twinning** section of the IP Office configuration and are **Twin Bridge Appearances**, **Twin Coverage Appearances** and **Twin Line Appearances**. In all cases they are subject to the secondary having the ability to indicate additional alerting calls.

Call alerting at the secondary phone ignoring any Ring Delay settings of the appearance button being used at the primary phone. The only exception is buttons set to No Ring, in which case calls are not twinned.

Busy on Held

For a user who has **Busy on Held** selected, when they have a call on hold, the IP Office system treats them as busy to any further calls. This feature is intended primarily for analog phone extension users. Within IP Office Manager, selecting **Busy on Held** for a user who also has line appearance keys will cause a prompt offering to remove the **Busy on Held** selection.

Reserving a Call Appearance Button

Functions such as transferring calls using a **Transfer** key require the user to have at least one available call appearance button in order to complete the outgoing call part of the process. However by default all call appearance buttons are available to receive incoming calls at all times.

It is possible to reserve the users last call appearance button for the making of outgoing calls only. The method for doing this depends on the IP Office system software level.

- **IP Office 4.0**
On the **User | Telephony** tab, select the option **Reserve Last CA**.
- **Pre-4.0 IP Office**
On the **User | Source Numbers** tab, enter the line **RESERVE_LAST_CA=** .

Appearance Functions and Logging Off and Hot Desking

IP Office users can be setup to log on and log off at different phones, this is called 'hot desking'. All the users settings, including their extension number, are transferred to the phone at which the user is logged on. This includes their key and lamp settings and appearance buttons.

This type of activity has the following effect on appearance buttons:

- If logged off, or logged on at a phone that doesn't support appearance button functions:
 - Bridged appearances set to the user will be inactive.
 - Call coverage set to the user will still operate.
- If logged on at a phone with fewer buttons than programmed for the user:
 - Those buttons which are inaccessible on the logged on phone will be inactive.
 - Any bridged appearances to those button from other users will be inactive.

Remote Hot Desking

IP Office 4.0 supports, through the addition of license keys, users hot desking between systems within an IP Office Small Community Network (SCN). However the use of appearance buttons (call coverage, bridged appearance and line appearance) within a Small Community Network is not supported. Therefore when a user logs on to a remote system, any such button that they have will no longer operate. Similarly any button that other users have with the remote user as the target will not operate.

Appearance Functions and IP Office Applications

A number of IP Office applications can be used to make, answer and monitor calls. These applications treat calls handled using key and lamp operation follows:

- **Phone Manager/SoftConsole**

These applications are able to display multiple calls to or from a user and allow those calls to be handled through their graphical interface.

 - All calls alerting on call appearance buttons are displayed.
 - Calls on line, call coverage and bridged appearance buttons are not displayed until connected using the appropriate appearance button
 - Connected and calls held here on all appearance button types are displayed.
 - The status of alerting call appearance calls, connected and held calls is shown in the Phone Manager's call status panel. Clicking on a call here can be used to answer or unhold a call. This action will place any current connected call on hold regardless of the system's Auto Hold setting.

Programming Appearance Buttons

Appearance Function System Settings

System settings are applied to all users and calls. The system settings that affect appearance operation are found on the System | Telephony tab and are:

- **Auto Hold:** *Default = On*
This setting sets whether a currently connected call should be held or disconnected when a user presses another appearance button.
- **Conferencing Tone:** *Default = Off (Tones on entry/exit only)*
When off, all parties in a conference or bridged call hear a single tone when a party joins the call and a double tone when a party leaves the call. When on, a tone is heard every 10 seconds during the conference or bridged call.
- **Ring Delay:** *Default = 5 seconds. Range = 1 to 98 seconds.*
This option is only available on IP Office 3.2 systems. It sets the delay used for any of the user's programmable buttons which have their ringing set to **Delayed**. This value can be overridden by a user specific **Ring Delay** value set through **User | Telephony**.

1. Start IP Office Manager and load the current configuration from the IP Office.
2. Select  **System**.
3. Select the **Telephony** tab.

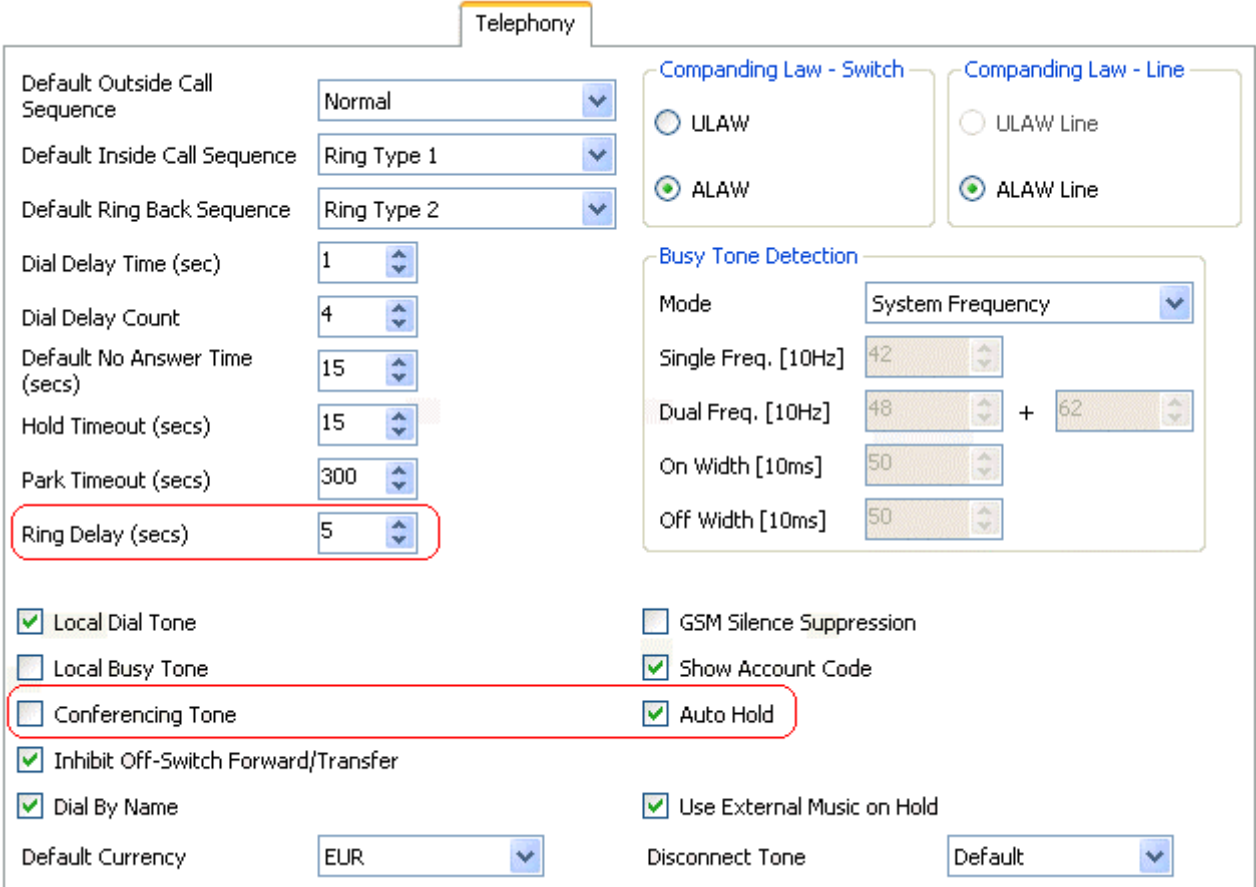

The screenshot shows the 'Telephony' configuration page in IP Office Manager. The 'Ring Delay (secs)' dropdown is highlighted with a red box and set to 5. The 'Conferencing Tone' checkbox is also highlighted with a red box and is unchecked. Other settings include 'Auto Hold' (checked), 'Busy Tone Detection' (Mode: System Frequency, Single Freq: 42, Dual Freq: 48 + 62, On Width: 50, Off Width: 50), and 'Local Dial Tone' (checked).

4. Adjust the highlighted settings as required.
5. Click **OK**.

Appearance Function User Settings

User settings are applied separately to each individual IP Office user. In addition to button programming, the following user settings are applicable to appearance button operation:

- **Cannot be Intruded:** *Default = On.*
This feature control whether other users can use their appearance buttons to join the users call. It applies when the user is the longest present internal party already within the call.
- **Individual Coverage Time:** *Default = 10 seconds. Range = 0 (immediate) to 9999.*
This feature sets how long a call will alert at the user's phone before also alerting on any call coverage buttons set to the user's name. It must be less than the systems **Default No Answer Time** or the user's **No Answer Time** if set.
- **Ring Delay:** *Default = Blank (Use system setting). Range = 1 to 98*
This option is only available on IP Office 3.2+ systems. It sets the delay used for any of the user's programmable buttons which have their ringing set to **Delayed**. This value, if set, overrides the system specific **Ring Delay** value set through **System | Telephony**.
- **Ringing Line Preference:** *Default = On.*
When on, this feature is used when the user has alerting calls but no connected call. It applies the currently selected button status to the appearance button that has been alerting the longest.
- **Idle Line Preference:** *Default = On.*
When on, this feature is used when the user's phone is idle. It sets currently selected button status to the user's first available call or line appearance button.
- **Delayed Ring Preference:** *Default = Off, Software Level = 4.0+.*
This setting is used in conjunction with ringing line preference and appearance buttons set to delayed or no ring. It sets whether ringing line preference should observe or ignore the delayed ring applied to the user's appearance buttons when determining which button should have current selected button status.
 - When on, ringing line preference is only applied to alerting buttons on which the ring delay has expired.
 - When off, ringing line preference can be applied to an alerting button even if it has delayed ring applied.
- **Answer Pre-Select:** *Default = Off, Software Level = 4.0+.*
Normally when a user has multiple alerting calls, only the details of the call on current selected button are shown. Pressing any of the alerting buttons will answer the call on that button, going off-hook will answer the current selected button. Enabling the user telephony setting **Answer Pre-Select** allows the user to press any alerting button to make it the current selected button and displaying its call details without answering that call. To answer a call when the user has **Answer Pre-Select** enabled, the user must press the alerting button to display the call details and then either press the button again or go off-hook.
- **Reserve Last CA:** *Default = Off, Software level = 4.0+.*
Used for users with multiple call appearance buttons. When present, this string stops the users last call appearance button from being used to receive incoming calls. This ensures that the user always has a call appearance button available to make outgoing calls and to initiate transfers and conferences. For pre-4.0 IP Office this option is set by adding the **RESERVE_LAST_CA=** option on the **User | Source Numbers** tab.
- **Abbreviated Ring:** *Default = On, Software level = 4.1+.*
This option controls the type of alerting ring given for additional appearance calls when a call is already connected. When on, additional calls alert with a single short ring. When off, additional calls alert will normal ringing. The audible alert is still subject to ring delay settings if enabled.

Programming User Settings using Manager

1. Start IP Office Manager and load the current configuration from the IP Office.
2. Select **User**.
3. Select the user whose settings you want to alter.
4. Select the **Telephony** tab.

Telephony

Outside Call Sequence	Default Ring	<input type="checkbox"/> Call Waiting On
Inside Call Sequence	Default Ring	<input checked="" type="checkbox"/> Answer Call Waiting On Hold (Analogue)
Ringback Sequence	Default Ring	<input checked="" type="checkbox"/> Busy On Held
No Answer Time (secs)		<input type="checkbox"/> Outgoing Call Bar
Wrap-up Time (secs)	2	<input type="checkbox"/> Offhook Station
Transfer Return Time (secs)		<input type="checkbox"/> Can Intrude
Individual Coverage Time (secs)	10	<input type="checkbox"/> Cannot be Intruded
Login Code		<input type="checkbox"/> Force Login
Login Idle Period (secs)		<input type="checkbox"/> Force Account Code
Monitor Group	<None>	<input type="checkbox"/> Force Authorization Code
Ring Delay (secs)		<input type="checkbox"/> System Phone
Call Cost Mark-Up	100	<input type="checkbox"/> Inhibit Off-Switch Forward/Transfer
Status on No-Answer	Logged On	<input type="checkbox"/> Reserve Last CA
Multi Line Options <input checked="" type="checkbox"/> Ringing Line Preference <input checked="" type="checkbox"/> Idle Line Preference <input type="checkbox"/> Delayed Ring Preference <input type="checkbox"/> Answer Pre-Select		<input type="checkbox"/> Can Trace Calls
Reset Longest Idle Time <input checked="" type="radio"/> All Calls <input type="radio"/> External Incoming		<input checked="" type="checkbox"/> Abbreviated Ring

5. The highlighted options above are those that relate specifically to appearance button usage. Adjust these settings as required.
6. Click **OK**.
7. Repeat for any other users.

Programming Line Appearance ID Numbers

Line appearances are supported for analog, E1 PRI, T1, T1 PRI, and BRI PSTN trunks. They are not supported for E1R2, QSIG and IP trunks.

Note that setting and changing line settings including line appearance ID numbers requires the IP Office system to be rebooted.

Automatic Renumbering

1. Select **Tools | Line Renumber**.
2. Select the starting number required for line numbering and click **OK**.
3. All lines that support **Line Appearance ID** will be numbered in sequence.

Manual Renumbering

1. Start IP Office Manager and load the current configuration from the IP Office.
2. Select **Line**.
3. Select the line required. The tab through which line appearance ID numbers are set will vary depending on the type of line. A couple of examples are shown below.

- **Analog Line:**

On the **Line Settings** tab select **Line Appearance ID** and enter the ID required.

Line Number	5
Telephone Number	
Incoming Group ID	0
Outgoing Group ID	0
Outgoing channels	1
Voice channels	1
Prefix	
National Prefix	0
Line Appearance ID	731

- **Basic/Primary Rate Trunks:**

On the **Channels** tab select the individual channel and click **Edit**. Select **Line Appearance ID** and enter the required ID, then click **OK**. Repeat for all the channels required.

Channel	Groups	Line Appearance
1	0 0	701
2	0 0	702
3	0 0	703
4	0 0	704
5	0 0	705
6	0 0	706
7	0 0	707
8	0 0	708
9	0 0	709
10	0 0	710

Channels	02
Incoming Group	0
Outgoing Group	0
Line Appearance Id	702

4. Click **OK** and repeat for any other lines.

Programming Appearance Buttons

This section covers the programming of appearance buttons for users into existing IP Office configurations.

- Call appearance buttons must start with button 1 and must be setup in a single block of buttons. Programming of just one call appearance is not supported. The normal default is 3 call appearance buttons unless the user regularly uses phones that support only two appearance buttons.
- Appearance functions programmed to buttons without suitable status lamps or icons are treated as disabled. These buttons are enabled when the user logs in on a phone with suitable buttons in those positions.
- Line appearance buttons require line ID numbers to have been assigned, see Programming Line Appearance Numbers.
 - The use of line appearances to lines where incoming calls are routed using DID (DDI) is not recommended.
- Bridged appearance buttons require the other user to already have call appearance buttons programmed.
- **How many buttons are allowed?**
The recommended limits are as follows:
 - A maximum of 10 bridged appearances to the same call appearance.
 - A maximum of 10 line appearances to the same line.
 - A maximum of 10 call coverages of the same covered user.

Programming Appearance Buttons Using IP Office Manager

If only button programming changes are required, the configuration changes can be merged back to the IP Office system without requiring a reboot.

1. Start IP Office Manager and load the current configuration from the IP Office system.
2. Locate and select the user for whom appearance buttons are required.
3. Select **Button Programming**.

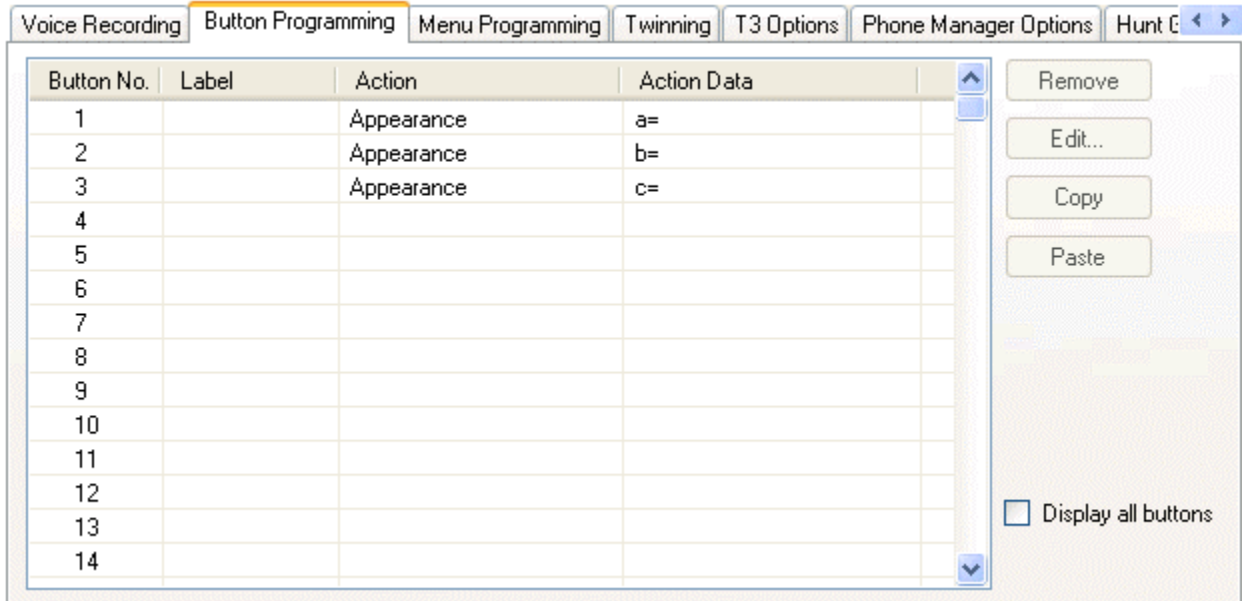

- The number of buttons displayed is based on the phone associated with the user when the configuration was loaded from the IP Office system. This can be overridden by selecting **Display all buttons**.
4. For the required button, click the button number and then click **Edit**.
 5. Click the ... button.

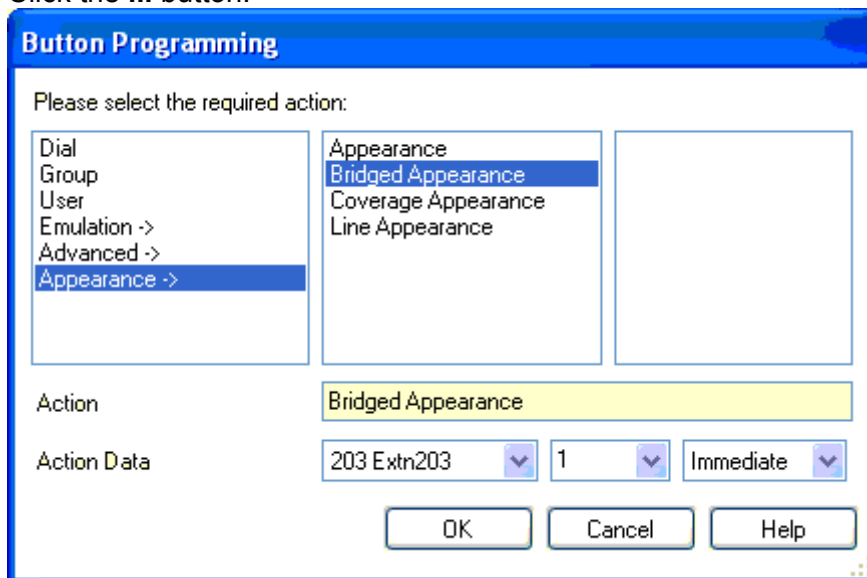

6. From the list of options that appears, click **Appearance**.
7. Select the type of appearance button required.
8. Use the **Action Data** drop-down fields to select the required settings. Click **OK**.
9. Repeat for any additional call appearance buttons required. Click **OK**.
10. Repeat for any other users requiring appearance buttons.

Outgoing Line Programming

Assigning line ID numbers to lines and associating line appearance buttons to those lines is sufficient for answering incoming calls on those lines. However, to use line appearance buttons for outgoing calls may require further programming.

Short Codes and Outgoing Line Appearance Calls

Once a line has been seized using a line appearance button, short code matching is still applied to the number dialed. That can include user, system and ARS or LCR short codes.

- The short codes matching must resolve to an off-switch number suitable to be passed direct to the line.
- The final short code applied must specify a 'dial' feature. This allows call barring of specific matching numbers to be applied using short codes set to features such as 'Busy'.

Line Appearance Hot Lines

A new short code feature has been added for scenarios where the associate line is an analog tie line or similar direct to another phone.

To use this feature:

- Create a new short code such as ***99*** with the feature **DialDirectHotLine**.
- Set ***99*** as the prefix for that line.

Upgrading from Pre-3.0 Systems

Upgrading from Pre 3.0 IP Office

Most of the aspects of appearance functions have no effect on systems being upgraded from versions of IP Office earlier than 3.0. However the following existing IP Office configuration settings are affected:

- **Call Appearance Buttons**
Call appearance buttons should start with button 1 and form a single block. On systems being upgraded where the call appearance buttons have been programmed differently, those buttons will be lost following the upgrade to 3.0.
- **Call Coverage**
Call coverage support was originally added in IP Office 1.3. Call coverage operation in IP Office 3.0 is a total replacement and uses different methods of setup and operation. If upgrading from a version earlier than 3.0, all existing call coverage settings will be lost. Therefore it is necessary to make manual notes of the covered and covering users before upgrading to IP Office 3.0 or higher.
- **Outgoing Call Routing**
If it is a requirement to use line appearance button for outgoing calls, then it will be necessary to add incoming line prefixes and to setup secondary dial tone short codes based on the same prefixes. See Outgoing Line Programming.

Call Handling Changes

People who have used phones on IP Office systems prior to IP Office software level 3.0 will find a number of changes to the way the phones operate.

- **Selected Button**

By default one appearance button is indicated as the current selected button. This is done either by the adjacent red LED being on or the button display label being underlined.

- The current selected button represents either the appearance button of the current connected call or the appearance button that will be used if the user goes off hook (ie. lifts the handset or presses the Speaker key).

- **Auto Hold**

The default operation of this feature depends on the phone system's locale:

- In the US, the default setting for **Auto Hold** is **off**. With a current call already connected on one appearance button, pressing another appearance key will disconnect the current call.
- Outside the US, the default setting for **Auto Hold** is on. With a current call already connected on one appearance button, pressing another appearance key will hold the current call.

- **Call Waiting**



Call waiting features are not applied to non-hunt group calls. Hunt group call waiting is applied, subject to the normal conditions for hunt group call waiting, but with the call waiting tone replaced by a call appearance button alert.

- **Busy Status**

For a user with call appearance buttons, you are busy when:

- For calls direct to your extension number, you are busy only when you have no further call appearance buttons available on which to present the call.
- For calls to any hunt group of which you are a member, you are busy to further group calls once you have a call connected unless hunt group call waiting is being used. However you may still receive additional calls dialed or forwarded direct to your extension number if you have any free call appearance buttons.
- In either case above, even when busy, you may be alerted on other types of appearance button, for example line appearance and call coverage.
- Busy on held can be used to return busy to further calls when you have an existing call on hold, however this is not recommended in conjunction with appearance buttons.

- **Retrieving Held Calls**

Pressing  **Hold** will put the current connected call on hold. The appearance button will indicate the held call with, depending on the phone type, a flashing green lamp or a  icon. However pressing  **Hold** again will not retrieve the held call.

- To retrieve a held call, press the appearance button against which the call was held.
- An intermittent green flashing lamp or an  icon indicate a call held by another user. These can also be retrieved by pressing that appearance button.

- **Transferring Calls**

To transfer calls, the  **Transfer** function of the phone or IP Office Phone Manager application should be used.

- **Joining Another Call**

Appearance buttons can indicate a call taking place elsewhere. You may be able to join that call by pressing the appearance button.

- Permission to join a call is controlled by the intrusion settings of the party who has been in the call the longest, not by your intrusion settings. See *Joining Other Calls* for full details.
- The joined call is a conference call and is subject to the IP Office's conference controls. If you press **Hold**, it is your connection to the conference that is held, it does not affect the other parties in the call.

- **Unparking Calls**

Parked calls can be indicated by buttons programmed to the Park function and a particular park slot number. These can be calls parked by the phone user or parked by other users. If the phone is idle, the parked call can be unparked by pressing the park button. If another call is connected on an appearance button, that call must be put on hold or ended before the parked call can be unparked.

- **Unprogrammed/Inaccessible Keys**

Buttons to which no function has been set or which the function is currently not useable, will produce a short burst of tone or ringing when pressed. If the button has an associated status lamp, it will also flash briefly.

- **Call Count**

Avaya IP Office phones with twin LED buttons display a call count. This appears as a digit count, for example **01** on the display. It increments for all calls that alert at a user's extension including missed and unanswered calls.

- Sequential calls from the same number do not increment the count more than once.
- Calls alerting on bridged, line and call coverage buttons are not included in the call count and history.
- The count is reset whenever the IP Office system is restarted.
- On Avaya 4400, 4600 and 6400 Series phones with a **MENU** key, details of the call count can be accessed and entries called or deleted. Press **MENU | MENU** and select **Hist**.

- **Call Log**

On 2410, 2420, 4610, 4620, 5410, 5420, 5610 and 5620, the call count is replaced by a **Log** function instead of the call count and history detailed above.

- **Self-Administration of Appearance Keys**

Previously users with a programmable button set to **Self-Administer (Admin)** could program their own call appearance buttons. In IP Office 3.0 this is no longer possible. In addition users cannot overwrite keys already programmed to an appearance function.

Twin LED Button Users

These notes are for users of Avaya phones which have twin LED lamps next to the programmable buttons. That is most 4400 Series, 6400 Series and older style 4600 Series phones.

- **Red LED On:** This is called the currently selected button. It indicates either the button that will be used if you go off-hook (pickup the handset or press the **Spkr** button) or the appearance button of the call to which you are currently connected. When your phone is idle your first call appearance button will show the red LED on.
- **Green LED:** The green LED is used as follows on appearance buttons:
 - **On/Off:** The button is in use/idle. This can include being used by another user, for example a line appearance button of a shared line.
 - **Flashing:** A call is alerting you.
 - **Fast Flash:** The call is on hold.
 - **Intermittent Flash:** The call has been put on hold by another user (on hold elsewhere).
- **Call Handling:** Having appearance keys means:
 - You can make and answer calls by pressing the appearance buttons.
 - **Auto Hold:** When connected to a call on one appearance button, pressing another appearance button will place the first call on hold and make/answer a call on the button pressed. For US systems this changes to disconnecting the first call.
 - **Transferring Calls:** To transfer a call, press **Trnsfr**, call the transfer destination and then press **Trnsfr** again.
 - **Retrieving Held Calls:** You cannot retrieve a held call by pressing **Hold** again. To retrieve a call from hold, press the appearance key associated with that call. Held calls are indicated by a fast flashing green lamp.
- **Busy Status:** Call appearance buttons allow you to make, receive and switch between multiple calls. This changes when the system returns busy to additional calls
 - **Hunt Group Calls:** You are seen as busy to further hunt group calls once you have any appearance button in use.
 - **Personal Calls:** You are seen as busy to further calls directed to your extension number once all your call appearance buttons are in use.
 - **Forward on busy**, if set, is only used when all your call appearance buttons are in use.
 - Even when busy, additional calls can alert you about other calls on call coverage, bridged appearance and line appearance button if programmed for you..
 - **Busy on Held** can be used but we strongly recommend it is avoided for appearance key users.
- **Joining a Call:** When an appearance button indicates a call in progress elsewhere. You may be able to use that button to join the call. Whether you are allowed to join the call depends on the **Cannot Be Intruded** setting of the user who has been in the call the longest.
- **Call waiting** settings are ignored for direct call to appearance button users. Hunt group call waiting can be used if setup.
- **Unprogrammed/Inaccessible Keys:** These keys will return a short tone and flash.
- **Self-Administration:** Users with access to this function can no longer program their own appearance keys or replace the programming of existing appearance buttons.
- **Hot Desking/Logging On:** If you move to a phone that doesn't have suitable programmable keys to support appearance buttons, you are treated as a normal PBX mode user while on that phone.

Twin LED Button Users Lamp States

The table below summarizes the meaning of the twin LED lamp states.

- **Selected** refers to the button indicating either the appearance button of the currently connected call or, if idle, the appearance button that would be used if the user goes off hook.

Feature	IP Office 2.1/3.0DT	IP Office 3.0+
Call Appearance Buttons		
- Idle.	All off.	All off.
- Idle: Selected.	–	Red on.
- Alerting.	Green flash.	Green flash.
- Alerting: Selected.	–	Red on, Green flash.
- In Use: Here.	Green on.	Red on, Green on.
- In Use: Elsewhere.	–	Green on.
- Held: Here.	Red on.	Green fast flash.
- Held: Elsewhere.	–	Green intermittent flash.
Other Buttons		
- Parked: Here	Green flash.	Green flash.
- Parked: Elsewhere	Red flash.	Red flash.
- User: Ringing	Red flash.	Green flash.
- User: In use.	Red on.	Green on.
- Group: Ringing.	Green Flash.	Green flash.
- Group: Queued.	Red flash.	Red flash.
- Other toggling features: On.	Green on.	Green on.
- Other toggling features: Off.	All off.	All off.
- Non-toggling features	All off.	All off.

The flash rate on button lamps is sometimes used to indicate different status. For example a fast flash is used for calls you put on hold and a intermittent flash for calls put on hold by someone else.

- **Steady Flash:** *****----- (0.5s on/0.5 s off/...) Used mainly to indicate alerting calls.
- **Fast Flash:** *-*-*-*-*-*-*- (50ms on/50ms off/...) Used mainly to indicate calls put on hold by you. This flash mode is also called 'Flutter'.
- **Intermittent Flash:** *----*----*----*---- (50ms on/200ms off/...) Used mainly to indicate calls on hold elsewhere, ie. put on hold by another user. This flash mode is also called 'Inverse Wink'.

Glossary

A

Abbreviated Ring: A technical term for the short ring given to indicate an alerting call when an appearance button user already has a connected call.

Alert: Refers to an appearance button indicating that it has received an incoming call. The actual method of alerting depends on the button type, ie. whether it uses indicator lamps or an adjacent display icon. Alerting may also be accompanied by ringing. If the user already has an existing call in connected, if ringing does occur, only a single ring (abbreviated ring) is given.

Appearance Button: A programmable button that has been programmed to one of the IP Office appearance functions: call appearance, bridged appearance, call coverage appearance and line appearance. These buttons can alert the user to incoming calls and be used to make outgoing calls.

B

BLF: Busy Lamp Field - A indicator, typically an LED lamp, that was used to indicate when the user associated with a DSS key was busy. Many Avaya phones have two colored lamps or a single dual colored lamp. Other Avaya phones use the adjacent area of the phones display screen.

Button: In the context of "key & lamp" operation, button and key mean the same thing.

C

Connected: A call that has been answered and is not on hold or parked.

Coverage Receiver: Technical gargon for a user with a call coverage button set to receive another users calls.

Coverage Sender: Technical gargon for the user being covered by another user who has a call coverage button.

Current Selected Button: The button that will be answered or used to make a call if the user goes off hook. The current selected button is normally indicated by the red lamp being on or an underscore under the button label.

D

Display Button: Some programmable buttons are represented by areas on the phone's display. This display area may show a text label for the current programmed button function and/or its status. The button is triggered by an adjacent physical key on the phone. The position of a display key may change and there may be more programmed display keys than physical keys adjacent to the display. In the later case the phone will provide some control for paging through the display keys.

DSS: Direct Station Select - A old term for a programmable button. A DSS key was programmed to dial a particular station (telephone).

F

Feature Key: See Programmable Button.

I

ICLID: Incoming Caller ID - Calling number signalling sent with the call. Also referred to as CLID and CLI.

K

Key & Lamp Operation: A general term for using programmable buttons and their associated indicator lamps or display icons.

O

Off Hook: Traditionally this refers to the user lifting the phones handset out of its cradle and off the hook switch located beneath the handset. However for phones that support handsfree and/or headset operation, the user can also go off hook by pressing a SPEAKER, HEADSET or ANSWER RELEASE key or pressing a call feature related programmed feature key.

P

Programmable Button: Interchangeable with the term "feature Key". Most Avaya phones have programmable buttons. Programmable buttons can be assigned to specific IP Office functions, which occur when the user presses that button. Many phones also include indicator lamps or display icons next to the programmable buttons. These are used to indicate the status of the programmable button function.

Index

- 0**
 - 0.5s on/0.5 62
- 2**
 - 20CC 8
 - 20DT 8
 - 2402D 8
 - 2410D 8
 - 2x12 8
 - 2x4 8
 - 2x6 8
- 3**
 - 3.0DT 8
 - excluding 8
 - 3x8 8
- 4**
 - 4406D 8
 - 4412D 8
 - 4424D 8
 - 4602IP/SW 8
 - 4610SW 8
 - 4x6 8
- 5**
 - 50ms on/200ms 62
 - 50ms on/50ms 62
 - 5602IP/SW 8
 - 5610SW 8
- 6**
 - 6400 Series 60, 62
 - 6408D 8
 - 6416D 8
 - 6424D 8
- A**
 - Abbreviated Ring 6, 52
 - Action Data 55
 - Use 55
 - Additional Notes 28
 - Admin 60
 - Alerting 40, 42
 - Line 40, 42
 - All Call Appearances
 - Alerting 33
 - Analog Line 40, 54
 - Another Call 12, 20, 35, 38, 42, 60
 - Joining 60
 - Another Call Arrives 35
 - Answer Call 26
 - Answer Pre-Select 5, 6, 32, 33, 35, 38, 39, 44, 45, 52
 - Answer Pre-Select 4.0 32
 - Answer pre-select allows 38
 - user 38
 - Appearance Button Features 6
 - appearance button indicates 62
 - call 62
 - Appearance Buttons 6, 9, 11, 12, 13, 18, 20, 29, 32, 33, 39, 40, 42, 44, 49, 50, 51, 52, 55, 60, 62
 - Programming 55
 - Appearance Buttons Using IP Office Manager 55
 - Programming 55
 - Appearance Function System Settings 51
 - Appearance Function User Settings 52
 - Appearance Functions 50, 51, 52, 60
 - appearance key 60, 62
 - Appearance Keys 60
 - Self-Administration 60
 - appearance shows 22, 28
 - call 22
 - Appearances 5, 6, 8, 9, 11, 12, 13, 15, 16, 18, 20, 21, 22, 23, 25, 27, 28, 29, 32, 33, 35, 39, 40, 42, 44, 45, 48, 49, 50, 51, 52, 54, 55, 57, 59, 60, 62
 - Collapsing 44
 - Appearances Alerting 33
 - Appearances Example 44
 - Collapsing 44
 - Appearances Treated 23, 28
 - ARS 57
 - Auto Connect Calls 40
 - Auto Hold 5, 6, 16, 20, 21, 22, 27, 33, 35, 39, 44, 50, 51, 60, 62
 - Auto Hold Example 39
 - Auto Hold Off 39
 - Auto Hold On 16, 20, 21, 22, 27, 39
 - Auto-Answer 40
 - auto-connection 40
 - Automatic Renumbering 54
 - Avaya 4400 60
 - Avaya 5421 5
 - Avaya phones 5, 6, 62
- B**
 - Basic/Primary Rate Trunks 54
 - BRI 6, 25, 54, 57
 - BRI PSTN 6, 25, 54
 - Bridge Appearance Button State 24
 - Bridged 5, 6, 12, 13, 17, 19, 20, 21, 22, 23, 24, 25, 28, 29, 35, 45, 48, 49, 50, 51, 55, 60, 62
 - Bridged Appearance 5, 6, 12, 13, 17, 19, 20, 21, 22, 23, 24, 35, 45, 48, 50, 55, 62
 - bridged appearance button follow 23
 - Bridged Appearance Button Indication 24
 - bridged appearance button shows 6, 19
 - user 6
 - Bridged Appearance Buttons 6, 12, 13, 19, 20, 22, 23, 24, 45
 - Bridged Appearance Example 20, 21, 22
 - Bridged Appearance User 12, 20, 21, 22, 23
 - bridged appearance user makes 21
 - call 21
 - bridged appearance user returns 21
 - Bridged Appearances Treated 23
 - Bridged Call 20, 22, 45, 48, 51
 - Holding 45
 - Bridged User Makes Call 21
 - Busy 9, 12, 16, 17, 49, 57, 60, 62
 - Busy on Held 49, 60, 62
 - Busy Status 60, 62
 - Button 5, 6, 8, 9, 10, 12, 13, 15, 16, 17, 18, 19, 20, 21, 23, 24, 25, 26, 27, 28, 29, 32, 33, 35, 38, 39, 40, 42, 44, 45, 48, 49, 50, 51, 52, 55, 57, 59, 60, 62
 - call alerting 42
 - Reserving 9
 - Selected refers 62
 - button follow 17
 - Button Indication 6, 32
 - button label 32
 - Button Programming 40, 52, 55
 - Select 55
 - Button Programming Manual 5
 - button receives 6
 - call 6
 - buttons allow 6, 25, 62
 - call 25
 - user 6
 - buttons display 60
 - buttons including 15
 - buttons show 6
 - user 6
 - Buttons Treated 12
 - Buttons Using 55
- C**
 - Call 5, 6, 8, 9, 10, 11, 12, 13, 15, 16, 17, 18, 19, 20, 21, 22, 23, 24, 25, 26, 27, 28, 29, 32, 33, 35, 38, 39, 40, 42, 44, 45, 48, 49, 50, 51, 52, 55, 57, 59, 60, 62
 - appearance button indicates 62
 - appearance shows 22
 - bridged appearance user makes 21
 - button receives 6
 - buttons allow 25
 - Covered User 16
 - Incoming 28
 - Joining 45, 62
 - Outgoing 28
 - settings control 17, 23
 - Transferring 62
 - User Answers 38
 - user joins 45
 - user leaves 45
 - Call Answered 10, 20, 27, 33, 45
 - Call Appearance 5, 6, 8, 9, 10, 11, 12, 13, 16, 19, 20, 21, 22, 23, 24, 28, 32,

- 33, 35, 38, 39, 40, 42, 44, 45, 48, 49, 50, 52, 55, 59, 60, 62
- Call Appearance
- Button Indication 13
- Call Appearance
- Button State 13
- Call Appearance
- Buttons 6, 9, 10, 12, 13, 19, 21, 23, 24, 33, 35, 38, 40, 42, 45, 48, 49, 52, 59, 60, 62
 - Reserving 49
- Call Appearance
- Buttons Treated 12
- Call Appearance
- Example 10, 11
- Call Appearance
- User 19, 20, 21, 22
- call arrives 12, 16
 - line 12
- call barring 57
- Call Between
- Colleagues 22
- Call Continues
- Alerting 42
- Call Count 60
- Call Coverage 5, 6, 12, 15, 16, 17, 18, 25, 28, 35, 48, 50, 52, 59, 60, 62
- Call coverage allows 15
 - user 15
- Call Coverage
- Appearance 5, 15, 17, 18, 28, 35, 48
- Call Coverage
- Appearance Buttons 15, 35, 48
- Call Coverage
- Button Indication 18
- Call Coverage
- Button State 18
- Call Coverage
- Example 16
- Call Coverage
- Treated 17
- call follows 17
 - user 17
- Call Handling 62
- Call Handling
- Changes 60
- Call Held 22, 33, 50, 60
- Call Log 60
- Call Put on Hold 21, 62
- call recording 28
- Call Routing 59
 - Outgoing 59
- Call Status 50
- Call Taken Off Hold 21, 22
- call timing 45
- Call Waiting 12, 42, 60, 62
- Call waiting settings 12, 62
- Calls
 - Transferring 60
- Calls Alerting 6, 16, 17, 20, 23, 27, 28, 33, 35, 38, 40, 42, 49, 50, 60
 - button 42
 - Coverage 16
 - User 42
- calls direct 12, 60
 - user's 12
- Calls forwarded 17
- calls ringing 17
- calls routed 17, 26, 40, 45, 48
 - user 40, 48
- Calls That Ignore 40
- Can Intrude 45
- Cannot 8, 13, 24, 27, 28, 29, 45, 52, 60, 62
 - use 45
- Cannot Be 8, 13, 24, 27, 28, 29, 45, 52, 62
- cannot be answered 28
- Cannot Be Intruded 62
- cannot retrieve 62
- Channel Name 29
- Channels 29, 54
- CLID 28
- Collapsing 44
 - Appearances 44
 - Appearances
 - Example 44
- Colleague 6, 16, 20, 21, 22, 45
- Colleague's Phone 20, 22
- CONFERENCE
- button 11, 44
 - Pressing 11, 44
- Conference Starts 11
- Conference
- Starts/Call
- Appearances
- Collapse 44
- conferencing 45
- Conferencing Center 45
- Conferencing Tone 45, 51
- Cover 5, 6, 12, 13, 15, 16, 17, 18, 24, 29, 31, 35, 44, 48, 55, 59
 - User 16
- User Answers 16
- Coverage 6, 16, 17, 18, 49, 55
 - Call Alerts 16
- Covered User 6, 16, 17, 18, 35, 48, 55
 - Call 16
- covered user alerting 35, 48
- Covering User
- Answers 16
- D**
- DDI 55
- Default No Answer
- Time 52
- Delay 6, 13, 18, 24, 26, 29, 32, 35, 40, 42, 45, 48, 51, 52
- Delayed Ring 35, 40, 48
 - set 40, 48
 - use 40
- Delayed Ring
- Preference 35, 40, 42, 52
- Delayed Ring
- Preference setting 40
- desking 50
- Dial 11, 13, 17, 24, 25, 29, 42, 45, 57, 59, 60
- DialDirectHotLine 57
- DID 55
- DND 23, 28
- Do Not Disturb 12, 17, 23, 28
- Do Not Disturb
- Exception list 12, 17
- E**
- E1 PRI 6, 25, 54, 57
- E1R2 6, 25, 54
 - including 25
- Edit 54, 55
- Enquiry Call
- Between Colleagues 22
- entering 9
 - RESERVE_LAST
 - _CA 9
- entry/exit 51
- Example 5, 10, 11, 12, 16, 20, 21, 22, 23, 26, 27, 33, 35, 38, 39, 40, 42, 44, 45, 48, 54, 57, 60, 62
 - Joining 45
- example
- telemarketing 33
- excluding 8
 - 3.0DT 8
- existing 55
 - IP Office 55
- External Calls 12, 45
- F**
- Fast Flash 13, 18, 24, 29, 62
- FEATURE 8
 - pressing 8
- Find 60
- First Call 10, 11, 20, 22, 33, 35, 38, 39, 42, 44, 45, 62
 - User 33, 35
- First Call Abandons 35
- First Call Alerting 38
- First Call Alerts 10, 35, 38
- First Caller
- Abandons 33, 35
- Flash 13, 18, 24, 29, 60, 62
- Flutter 62
- Follow Me 12, 17
- Forward Hunt Group
- Calls 12
- Forward on Busy 9, 12, 62
- Forward
- Unconditional 12
- G**
- Goes Off Hook 6, 13, 18, 29, 32, 33, 60, 62
- Green flash 62
- H**
- HEADSET 33
- hear 42, 45, 51
 - IP Office
 - conferencing 45
- hears ringing 42
- Held 12, 13, 17, 18, 21, 24, 27, 29, 50, 51, 60, 62
- held call 60
- Held Calls 12, 13, 21, 27, 60, 62
 - Retrieving 60, 62
- Held/Parked Call
- Timeout 12
- Hist 60
- Hold 6, 10, 11, 12, 13, 18, 19, 21, 22, 23, 24, 27, 29, 32, 33, 38, 39, 40, 44, 45, 49, 50, 60, 62
 - Bridged Call 45
 - Pressing 60, 62
- Hold Elsewhere 12, 13, 21, 22, 23, 24, 29, 62
- Hold Here 13, 18, 24, 29, 45
- Hot Desking 50
- Hot Desking/Logging
- On 62

- Hunt group call
waiting 12, 60, 62
Hunt Group Calls 12,
60, 62
- I**
- ICLID 26, 28, 40, 45
IP Office waits 28
set 28
- ID 25, 26, 45, 54, 55,
57
- Idle Line Preference
32, 33, 35, 38, 40,
42, 44, 45, 52
- Idle Line Preference
determines 33
user's 33
- Idle Line Preference
Example 33
- ie 19, 35, 60, 62
- Immediate 6, 40, 48,
52
set 40, 48
- including 25
E1R2 25
- Incoming 28
Calls 28
- Incoming Call Route
25
- Individual Coverage
Time 15, 16, 17, 48,
52
- Initial Call 11, 44
- Intermittent Flash 13,
24, 29, 62
- Internal 40
- Internal Auto-Answer
40
- International Prefix
57
- Intruded 27, 45, 52,
62
- Inverse Wink 62
- IP 5, 6, 8, 15, 17, 25,
28, 29, 32, 35, 38,
39, 40, 45, 49, 50,
51, 52, 54, 55, 59,
60, 62
- IP Office 5, 6, 8, 15,
17, 25, 28, 29, 32,
35, 38, 39, 40, 45,
49, 50, 51, 52, 54,
55, 59, 60, 62
existing 55
number 50
requires 54
subject 60
- IP Office 1.3. 15, 59
- IP Office 2.1/3.0DT
62
- IP Office 3.0 5, 6, 8,
25, 59, 60, 62
running 8
upgrading 59
- IP Office 3.0. 15
- IP Office 3.0DT 5
- IP Office 3.2 6, 35,
40, 51, 52
running 40
- IP Office 3.2 adds 6
- IP Office 5420 35
- IP Office
Applications 50
- IP Office Button
Programming
Manual 5
- IP Office
conferencing 45
hear 45
- IP Office
Conferencing Center
45
- IP Office
Conferencing
Resources 45
- IP Office employs 6
- IP Office incoming
call 17, 25
- IP Office Key 5
- IP Office Manager 9,
29, 49, 55
- IP Office Phone
Manager application
60
- IP Office Phones 8,
60
- IP Office Software
Level 8, 60
- IP Office waits 28, 40
ICLID 28
- J**
- Joining 45, 60, 62
Another Call 60
Call 62
Calls 45
Example 45
- L**
- Lamp Operation 5, 6,
9, 50
- LCR 57
- LED 32, 60, 62
- Line 5, 6, 12, 17, 23,
25, 26, 27, 28, 29,
32, 33, 35, 40, 42,
44, 45, 48, 49, 50,
52, 54, 55, 57, 59,
60, 62
Alerting 40, 42
calls arriving 12
- Line 601 35, 45
- Line Appearance 5,
6, 12, 17, 25, 26, 27,
28, 29, 32, 33, 35,
40, 42, 44, 45, 48,
49, 50, 52, 54, 55,
57, 59, 60, 62
- Line Appearance
Alerting 26, 45
- Line Appearance
Button Indication 29
- Line Appearance
Button State 29
- Line Appearance
Buttons 6, 12, 25,
28, 29, 32, 33, 35,
40, 42, 45, 48, 52,
57, 59, 62
- Line Appearance
Example 26, 27
- Line Appearance Hot
Lines 57
- Line Appearance ID
25, 29, 54
- Line Appearance ID
Numbers 54
Programming 54
- Line Appearances
Treated 28
- Line Goes Active 26,
45
- Line Group ID 57
specify 57
- Line Held 27
- Line Name 29
- Line Preference 32,
33, 35, 44, 48, 52
Ringing 32, 33,
35, 44, 48, 52
- Line Preference
Example 35
Ringing 35
- Line Preference
Order 35, 48
Ringing 35, 48
- Line Programming
57
Outgoing 57
- Line Renumber 54
- Line Retrieved 27
- Line Settings 54
- Log 23, 50, 55, 60
- Logging Off 23, 50
- Loop Start ICLID 40
set 40
- M**
- Make Conference
Enquiry 11, 44
make/answer 62
make/receive 39
Manager 50, 52
Manual
Renumbering 54
matches 12, 13, 20,
21, 22, 23, 24, 45, 57
Outgoing Group
ID 57
- Maximum Two
Analog Trunks 45
- MENU 60
- MENU key 60
- Multiple Alerting 48
- Multiple Alerting
Appearance Buttons
48
- Multiple Alerting
Buttons 40
- N**
- National Prefix 57
- No Answer Time 17,
52
- No Ring 35, 40, 48,
49
set 40, 48
- No Ring set 35, 40
number 5, 6, 8, 9,
12, 16, 17, 25, 26,
29, 45, 49, 50, 52,
54, 55, 57, 60, 62
IP Office 50
- O**
- Off, Software 52
- Off, Software Level
52
- OK 51, 52, 54, 55
- Other Buttons 42,
48, 62
- Outgoing 28, 57, 59
Call Routing 59
Calls 28
Line
Programming 57
- outgoing call part 49
- Outgoing Call
Routing 59
- Outgoing Calls 9, 25,
33, 49, 59
Using Line
Appearances 25
- Outgoing Group ID
57
matches 57
- Outgoing Line
Appearance Calls 57
- P**
- Park 12, 17, 28, 40,
45, 60, 62
- Parked Calls 12, 45,
60, 62
Retrieving 62
- PBX 62
- Personal Calls 62
- Phone 5, 6, 8, 9, 10,
11, 12, 13, 16, 17,
18, 19, 20, 21, 23,
24, 25, 26, 28, 29,
32, 33, 35, 38, 40,
42, 44, 45, 49, 50,
52, 55, 57, 60, 62
Transfer function
60
- Phone Idle 10, 16,
20, 21, 33, 35, 38,
40, 42
phone ignoring 49

- Phone Manager/SoftConsole 50
- Phone Manager's 50
- phones display 5, 13
- phones show 19
- Pre 3.0 IP Office 59
- pre-3.0 IP Office 15
- pre-4.0 49, 52
- Prefix 25, 57, 59
- Press MENU 60
- Pressing 8, 10, 11, 33, 44, 60, 62
 - CONFERENCE button 11, 44
 - FEATURE 8
 - Hold 60, 62
 - Second Call Appearance 10
 - SPEAKER 33
 - Spkr button 62
- Programming 52, 54, 55, 57
 - Appearance Buttons 55
 - Appearance Buttons Using IP Office Manager 55
 - Line Appearance ID Numbers 54
 - User Settings 52
- Q**
- Q2 2007 29
- QSIG 6, 25, 54
- R**
- Range 8, 40, 51, 52
- Red LED On 62
- Refer 29
 - SHOW_LINEID_NOT_OUTSIDE 29
- Remote Hot Desking 50
 - requires 6, 9, 13, 18, 25, 27, 28, 49, 51, 52, 54, 55, 57
 - IP Office 54
- Reserve Last CA 49, 52
- RESERVE_LAST_CA 9, 49, 52
 - entering 9
- Reserving 9, 49
 - Button 9
 - Call Appearance Buttons 49
- Retrieving 60, 62
 - Held Calls 60, 62
 - Parked Calls 62
- Ring Delay 6, 28, 35, 40, 42, 48, 49, 51, 52
- ringback 45
- Ringing 32, 33, 35, 40, 44, 48, 52
 - Line Preference 32, 33, 35, 44, 48, 52
 - Line Preference Example 35
 - Line Preference Order 35, 48
- Ringing Line Preference 6, 13, 16, 18, 20, 21, 22, 23, 24, 26, 27, 28, 29, 32, 33, 35, 38, 40, 42, 44, 45, 48, 52
- Ringing Line Preference determines 35
 - user's 35
- Ringing Line Preference keeps 33, 35
- Ringing Line Preference Order 35, 48
- Ringing Line Preference retain 35
- running 8, 40
 - IP Office 3.0 8
 - IP Office 3.2 40
- S**
- SCN 6, 50
- Second Call 10, 20, 35, 38, 39
 - User 35
- Second Call Alerting 38
- Second Call Alerts 10, 35, 38
- Second Call Appearance 10, 35, 38, 39
 - Pressing 10
 - Select 6, 9, 13, 18, 23, 24, 25, 26, 28, 29, 32, 33, 35, 38, 40, 42, 45, 48, 49, 51, 52, 54, 55, 60, 62
 - Button Programming 55
 - Telephony 51, 52
- Select Line 54
- Select Line Appearance ID 54
- Select System 51
- Select Tools 54
- Select User 52
- Selected refers 62
 - button 62
- selecting Display 55
- Selection 23, 28, 32, 49
- Self-Administer 60
 - set 60
- Self-Administration 60, 62
 - Appearance Keys 60
 - Series phones 62
 - set 6, 12, 15, 17, 22, 27, 28, 32, 33, 35, 38, 39, 40, 42, 44, 45, 48, 49, 50, 51, 52, 54, 57, 60, 62
 - Delayed Ring 40, 48
 - ICLID 28
 - Immediate 40, 48
 - Loop Start ICLID 40
 - No Ring 40, 48
 - Self-Administer 60
 - setting Answer Pre-Select 6, 32, 52
 - setting Answer Pre-Select allows 6, 32, 52
 - user 6, 32, 52
 - setting Reserve Last CA 6
 - Settings 6, 9, 12, 17, 23, 28, 40, 48, 49, 50, 51, 52, 54, 55, 59, 60, 62
 - settings control 17, 23
 - call 17, 23
 - settings including 54
 - short code removes 57
 - Short Codes 25, 45, 57
 - SHOW_LINEID_NOT_OUTSIDE 29
 - Refer 29
 - Small Community Network 6, 15, 17, 19, 23, 25, 28, 45, 50
 - Software 52
 - Source Number 9, 49
 - Source Numbers 9, 49, 52
 - SPEAKER 33
 - pressing 33
 - Speaker key 60
 - Special behaviour 25
 - specify 25, 57
 - Line Group ID 57
 - Spkr button 62
 - press 62
 - Start IP Office Manager 51, 52, 54, 55
 - Steady Flash 13, 18, 24, 29, 62
 - subject 6, 19, 49, 52, 60
 - IP Office's 60
 - Summary 31
 - System 5, 6, 8, 15, 17, 19, 22, 23, 25, 28, 29, 32, 38, 39, 40, 42, 44, 45, 49, 50, 51, 52, 54, 55, 57, 59, 60, 62
 - System | Telephony 40, 51, 52
 - system programming 28
 - System Settings 32, 38, 40, 45, 51, 52
 - systems running 8, 29, 40
 - T**
 - T1 6, 25, 54, 57
 - T1 PRI 6, 25, 54
 - T3 Classic 8
 - T3 Comfort 8
 - T3 Compact 8
 - T3 IP Classic 8
 - T3 IP Comfort 8
 - T3 IP Compact 8
 - Telephony 6, 32, 40, 49, 51, 52
 - Select 51, 52
 - Transfer 52, 60
 - Transfer function 60
 - phone 60
 - Transfer key 49
 - Transferring 6, 9, 17, 40, 49, 50, 52, 60, 62
 - Calls 60, 62
 - Transtalk 9040 32
 - Trnsfr 62
 - Twin 6, 32, 40, 49, 60, 62
 - Twin LED Button Users 62
 - Twin LED Button Users Lamp States 62
 - Twinned Line/Bridge/Coverage Appearances 6
 - U**
 - unhold 50
 - unpark 62
 - unparked 28, 45, 60
 - Unparking Calls 60
 - Unprogrammed/Inaccessible Keys 60, 62
 - upgrading 59
 - IP Office 3.0 59
 - US 6, 39, 51, 57, 60, 62
 - US PRI 57
 - Use 5, 6, 9, 11, 12, 13, 18, 20, 21, 22,

- 23, 24, 25, 26, 28, 29, 32, 33, 35, 38, 40, 42, 44, 45, 50, 52, 55, 57, 59, 62
 - Action Data 55
 - Cannot 45
 - Delayed Ring 40
 - Use Elsewhere 12, 13, 20, 21, 22, 24, 26, 28, 29, 44, 45
 - Use Here 13, 18, 24, 29, 45
 - Use Just 33
 - use/idle 62
 - Used 5, 6, 8, 9, 12, 13, 15, 18, 19, 25, 26, 28, 29, 32, 35, 40, 42, 45, 48, 49, 50, 51, 52, 57, 60, 62
 - User 5, 6, 9, 10, 11, 12, 13, 15, 16, 17, 18, 19, 20, 21, 22, 23, 24, 25, 26, 27, 28, 29, 32, 33, 35, 38, 39, 40, 42, 44, 45, 48, 49, 50, 51, 52, 55, 57, 59, 60, 62
 - Answer pre-select allows 38
 - bridged appearance
 - button shows 6
 - buttons allow 6
 - buttons show 6
 - Call Alerting 42
 - Call coverage allows 15
 - call follows 17
 - calls direct 12
 - calls routed 40, 48
 - Covering 16
 - First Call 33, 35
 - Idle Line Preference determines 33
 - Ringing Line Preference determines 35
 - Second Call 35
 - setting Answer Pre-Select allows 6, 32, 52
 - User Answers 16, 19, 38
 - Call 38
 - Covering 16
 - user joins 45
 - call 45
 - user leaves 45
 - call 45
 - user lifts 42
 - User Makes Call 21
 - User Presses 38
 - User Settings 52
 - Programming 52
 - user wants 40, 42
 - users exchange 27
 - user's forwarding 28
 - user's forwarding settings 28
 - Users Lamp States 62
 - Using Line Appearances 25, 27
 - Outgoing Calls 25
- V**
- voicemail 9, 12, 17, 28, 40, 45, 49
 - Voicemail On 12
 - Voicemail ringback 17, 40
 - VoIP 45
- W**
- Why Would 33
 - Within IP Office Manager 9, 49

Performance figures and data quoted in this document are typical, and must be specifically confirmed in writing by Avaya before they become applicable to any particular order or contract.

The company reserves the right to make alterations or amendments to the detailed specifications at its discretion. The publication of information in this document does not imply freedom from patent or other protective rights of Avaya or others.

Intellectual property related to this product (including trademarks) and registered to Lucent Technologies have been transferred or licensed to Avaya.

All trademarks identified by the ® or ™ are registered trademarks or trademarks, respectively, of Avaya Inc. All other trademarks are the property of their respective owners.

This document contains proprietary information of Avaya and is not to be disclosed or used except in accordance with applicable agreements.

Any comments or suggestions regarding this document should be sent to "wgctechpubs@avaya.com".

© 2007 Avaya Inc. All rights reserved.

Avaya
Unit 1, Sterling Court
15 - 21 Mundells
Welwyn Garden City
Hertfordshire
AL7 1LZ
United Kingdom

Tel: +44 (0) 1707 392200
Fax: +44 (0) 1707 376933

Web: <http://www.avaya.com/ipoffice/knowledgebase>